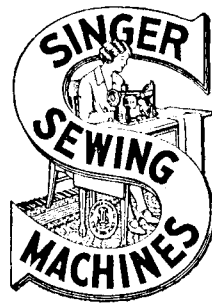


SINGER

29W

LIST OF PARTS



MACHINES

Nos. 29w2, 29w6, 29w11, 29w14,
29w15, 29w17, 29w21,
29w23 and 29w27

THE SINGER MANUFACTURING COMPANY

INDEX

| | PAGE |
|-------------------------------|------|
| ACCESSORIES | 74 |
| BOBBIN WINDER | 74 |
| FEED DOGS | 77 |
| " WHEELS | 77 |
| KNEE LIFTER | 75 |
| KNIFE GRINDER | 92 |
| KNIVES | 93 |
| MACHINE No. 29w2 | 7 |
| " " 29w6 | 17 |
| " " 29w11 | 27 |
| " " 29w14 | 28 |
| " " 29w15 | 38 |
| " " 29w17 | 49 |
| " " 29w21 | 60 |
| " " 29w23 | 72 |
| " " 29w27 | 73 |
| NUMERICAL LIST OF PARTS | 97 |
| OBSOLETE PARTS | 93 |
| ROLLER PRESSERS | 78 |
| THROAT PLATES | 79 |

From the library of: Diamond Needle Corp.

Instructions for Ordering

In ordering from this list, use **ONLY** the **PART** number in the **FIRST** column

The number stamped on a Sewing Machine Part is the number of the Single Part only, except when the part includes Set Screws, Clamping Screws, Studs and Rollers Spun on, Small Wires riveted, or Parts soldered together, etc., which it is necessary to furnish in combination.

Every combination of parts sent out has its specific number which, although not stamped on Parts (except in above cases) must be used when ordering the combination.

Each number always indicates the **SAME PART** in whatever list it appears, or for whatever Machine.

The letters after some of the numbers indicate the style of finish only, as follows:

- A. Hardened, Polished and Plated.
- B. Polished and Plated.
- C. Hardened only.
- D. Polished only.
- E. Soft, not polished.
- F. Hardened and Polished.
- H. Blued.

These letters **MUST BE USED** when they appear in the list and **AFTER** the number, as in the list.

In this series

200001 to 201500 are Screw Numbers.

201501 to 201800 are Nut Numbers.

201801 to 202000 are Roller Numbers.

202001 and upward are numbers of Machine Parts.

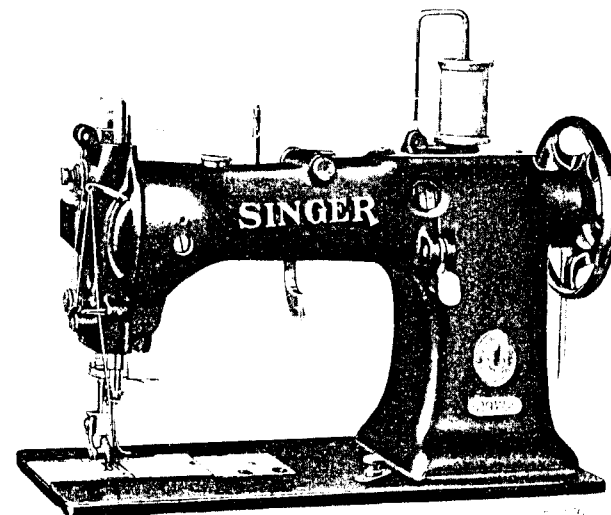
The figures in the second column refer only to the plate in which the illustration of the part is shown and are **NOT TO BE USED** in ordering.

Two or more numbers over a cut indicate that the difference between such parts is not visible in an illustration.

Parts marked with an asterisk (*) are furnished only when repairs are made at the factory.

LIST OF PARTS COMPLETE

FOR



MACHINE No. 29w2

DROP FEED. VERTICAL SEAM TRIMMER

For Leather and Gloves

| No. | Plate | Name |
|---------|-------|--|
| *213143 | --- | Arm |
| 213921 | 11282 | " Cap |
| 200278H | 12311 | " " Screw |
| 202248 | 11285 | " " " Washer |
| 203089 | 11282 | " " Spool Holder Base |
| 203090 | 11282 | " " " " " 203089 with 200079H and 204296 |
| 200585H | 11285 | Arm Cap Spool Holder Base Screw |
| 204296 | 11282 | " " " " Wire |
| 200079H | 12311 | " " " " Hinge Screw |
| 213922 | --- | Arm Cap and Spool Holder complete, Nos. 203090, 213921 and two 200585H |
| 200010E | --- | Arm Screw (3) |
| 202005 | 11285 | " " Washer (3) |
| 213158 | 11281 | " Shaft |

From the library of: Diamond Needle Corp

| No. | Plate | Name |
|---------|-------|--|
| 223431 | --- | Arm Shaft 213158 with 200244d, 200245d, 213150, 213354, 213654, 213655, 223429, 223430 and two 201528e |
| 204801 | 11282 | Arm Shaft Bushing (back) with 202260 |
| 202260 | --- | Arm Shaft Bushing (back) Oil Packing (wick) |
| 200338c | 11048 | Arm Shaft Bushing (back) Set Screw |
| 213299 | 11282 | Arm Shaft Bushing (center) with 202260 |
| 202260 | --- | Arm Shaft Bushing (center) Oil Packing (wick) |
| 200338c | 11048 | Arm Shaft Bushing (center) Set Screw |
| 204802 | 11282 | Arm Shaft Bushing (front) with 202036 and 202260 |
| 202260 | --- | Arm Shaft Bushing (front) Oil Packing (wick) |
| 200502n | 11285 | Arm Shaft Bushing (front) Oil Packing Thumb Screw |
| 202036 | 11285 | Arm Shaft Bushing (front) Position Pin |
| 200341c | 11285 | Arm Shaft Bushing (front) Set Screw |
| 204804 | 11281 | Arm Shaft Connection with four 200054e (2) |
| 200054e | 11285 | Arm Shaft Connection Screw |
| 213153 | 11281 | Balance Wheel, 5 $\frac{1}{2}$ in. diam. (belt groove 2 $\frac{3}{4}$ in. diam.), with 200328c and 200335c |
| 200062n | 12311 | Balance Wheel Adjusting Screw .. |
| 200328c | 12311 | " " Position Screw |
| 200335c | 12311 | " " Set Screw |
| *213652 | --- | Bed with 203248, 203249, two each 200362c, 200516e, 200840e and 202299 |
| 202258 | 12153 | Bed Hinge Connection (2) |
| 200570e | 12311 | " " " Screw (4) |
| 203329 | 11282 | " Slide (back) |
| 203207 | 11282 | " " (front) |
| 203208 | 11284 | Bobbin |
| 203210 | 11284 | " Case Base with 202056, 203211 to 203213 and 203216 |
| 203211 | 11284 | Bobbin Case Base Latch |
| *202056 | --- | " " " " Pin |
| 203212 | 11284 | " " " " Plunger .. |
| 203213 | 11284 | " " " " Spring ... |

| No. | Plate | Name |
|---------|-------|---|
| 203209 | 11284 | Bobbin Case Cap with 200984c, 203214, 203215 and two 200594c.. |
| 203214 | 11284 | Bobbin Case Tension Spring |
| 200984c | 11284 | " " " " Regulat- ing Screw |
| 200594c | 11284 | Bobbin Case Tension Spring Screw |
| 203215 | 11284 | " " Thread Guide |
| 200594c | 11284 | " " " " Screw .. |
| 203216 | --- | " " Washer (cloth) |
| 203217 | 11284 | Bobbin Case complete, Nos. 203209 and 203210 |
| 223421 | 14102 | Face Plate with 200366n, 200368n, 202087, 202090, 204185 and two 200397n |
| 200065c | 11285 | Face Plate Screw (2) |
| 204185 | 11292 | " " Thread Guide |
| 200397n | 12349 | " " " " Set Screw |
| 223422 | --- | Face Plate complete, Nos. 200309e, 200577n, 202088, 204059, 204272, 204280, 223421 and 223423 |
| 213146 | 11282 | Feed Bar |
| 213229 | --- | " " 213146 with 200641c, 201522e and 213147 |
| 200641c | 11048 | Feed Bar Hinge Screw |
| 201522e | 11285 | " " " " Nut |
| 207651 | 14106 | " Dog |
| 200106e | 12311 | " " Screw (2) |
| 223429 | 11298 | " Driving Eccentric (adjustable) |
| 223430 | 11298 | " " " Adjusting Disc |
| 213150 | 11282 | " " " Flange with 200378c and 200437c |
| 200437c | 12311 | Feed Driving Eccentric Flange Position Screw |
| 200378c | 12311 | Feed Driving Eccentric Flange Set Screw |
| 213655 | 11048 | Feed Driving Eccentric Friction Spring Washer |
| 200245d | 11048 | Feed Driving Eccentric Friction Spring Washer Screw |
| 201528e | 11285 | Feed Driving Eccentric Friction Spring Washer Screw Nut |
| 200244d | 11048 | Feed Driving Eccentric Fulcrum Screw |
| 201528e | 11285 | Feed Driving Eccentric Fulcrum Screw Nut |
| 213147 | 11281 | Feed Driving Rock Shaft |
| 202305 | 11285 | " " " " Center (2) |
| 200043c | 12311 | " " " " Set Screw (2) |

| No. | Plate | Name |
|----------|-------|--|
| 213354 | 11281 | Feed Driving Rock Shaft Connection with 200054E and 202277 ... |
| 213654 | 11048 | Feed Driving Rock Shaft Connection Collar |
| 202298 | 11048 | Feed Driving Rock Shaft Connection Crank with 200038c |
| 200038c | 11048 | Feed Driving Rock Shaft Connection Crank Pinch Screw |
| 200545c | 11048 | Feed Driving Rock Shaft Connection Hinge Screw |
| 201518E | 11285 | Feed Driving Rock Shaft Connection Hinge Screw Nut |
| 202277 | --- | Feed Driving Rock Shaft Connection Oil Packing (wick) |
| 209054E | 11285 | Feed Driving Rock Shaft Connection Pinch Screw |
| 213627 | 11285 | Feed Lifting Cam with 202126 |
| 204202 | 11285 | " " " Fork with 200027E |
| 200027E | 11285 | " " " " Pinch Screw |
| 202126 | 11285 | " " " Position Pin |
| 200045E | 11285 | " " " Screw |
| 203236 | 11281 | " " Rock Shaft |
| 203316 | 11281 | " " " " 203236 with 203238 |
| 202305 | 11285 | Feed Lifting Rock Shaft Center (2) |
| 200043c | 12311 | " " " " " Set Screw (2) |
| 202276 | 11285 | Feed Lifting Rock Shaft Slide Block |
| 203238 | 11285 | " " " " " " 202276 with 200243E and 201531E |
| 200243E | 11285 | Feed Lifting Rock Shaft Slide Block Hinge Screw |
| 201531E | 11285 | Feed Lifting Rock Shaft Slide Block Hinge Screw Nut |
| 213161 | 11048 | Feed Regulating Lever with 213657 |
| 200665c | 11048 | " " " Hinge Screw |
| 213656 | 14104 | " " " Spring |
| 213657 | 14104 | " " " " Pin .. |
| *203463 | --- | Hook (sewing) |
| 203464 | 11241 | " 203463 with 201253F, 201376F and 203251 |
| 203465 | 11241 | Hook and Bobbin Case complete, Nos. 203217 and 203464 |
| 203241 | 11007 | Hook Bevel Gear Socket, 24 teeth |
| 200555II | 11007 | " " " " Screw ... |
| 203242 | 11007 | " " Pinion, 24 teeth, with two 200383c |
| 200383c | 12311 | Hook Bevel Pinion Set Screw |
| 203243 | 11281 | " Counter Shaft |

| No. | Plate | Name |
|---------|-------|--|
| 203244 | 11007 | Hook Counter Shaft Collar with two 200393c |
| 200393c | 11007 | Hook Counter Shaft Collar Set Screw |
| 203245 | 11007 | Hook Counter Shaft Driving Gear, 44 teeth, with 200362c and 200439c |
| 213155 | --- | Hook Counter Shaft Driving Gear 203245 with 200045E and 213627 .. |
| 200439c | 12311 | Hook Counter Shaft Driving Gear Position Screw |
| 200362c | 12311 | Hook Counter Shaft Driving Gear Set Screw |
| 203246 | 11007 | Hook Counter Shaft Gear, 22 teeth, with two 200383c |
| 200383c | 12311 | Hook Counter Shaft Gear Set Screw |
| 202299 | --- | " " " Oil Packing (wick) |
| 200840E | 11007 | Hook Counter Shaft Oil Packing (wick) Stop Screw |
| 203247 | 11281 | Hook Driving Shaft |
| 203248 | 11288 | " " " Bearing with 202299 |
| 202299 | --- | Hook Driving Shaft Bearing Oil Packing (wick) |
| 202126 | 11285 | Hook Driving Shaft Bearing Position Pin |
| 200516E | 12311 | Hook Driving Shaft Bearing Screw |
| 203249 | 11007 | " " " Bushing (eccentric) |
| 202299 | --- | Hook Driving Shaft Bushing Oil Packing (wick) |
| 200362c | 12311 | Hook Driving Shaft Bushing Set Screw |
| 213141 | 14107 | Hook Driving Shaft Collar with two 200393c |
| 200393c | 11007 | Hook Driving Shaft Collar Set Screw |
| 203251 | 11284 | Hook Gib |
| 201376F | 14104 | " " Hinge Screw |
| 201253F | 14104 | " " Screw |
| 203252 | 11288 | " Saddle with 202299 |
| 202299 | --- | " " Oil Packing (wick) |
| 200019E | 11285 | " " Screw (2) |
| 202622 | 11285 | " " " Washer (2) |
| 203718 | 11241 | " Washer |
| 203466 | 11288 | Hook Saddle complete, Nos. 200555II, 203241, 203252, 203465 and 203718 |
| 228184 | 11108 | Knee Lifter Connection Lever with 202446 |

| No. | Plate | Name |
|---------|-------|---|
| 200224H | 11285 | Knee Lifter Connection Lever Hinge Screw |
| 213879 | 14108 | Knee Lifter Connection Lever Lifting Rod with 202302 |
| 202302 | 14104 | Knee Lifter Connection Lever Lifting Rod Cotter Pin |
| 202446 | 14101 | Knee Lifter Connection Lever Pin |
| 228181 | 14102 | " " Lifting Lever |
| 228183 | --- | " " " " 228181 with 201178H, 201527H and 228182 |
| 228182 | 14102 | Knee Lifter Lifting Lever Bracket |
| 200570E | 12311 | " " " " " " Screw |
| 201178H | 14103 | Knee Lifter Lifting Lever Hinge Screw |
| 201527H | 14103 | Knee Lifter Lifting Lever Hinge Screw Nut |
| 207805 | 10620 | Knife |
| 202887 | 11289 | " Bar |
| 202888 | 11289 | " " 202887 with 202894, 202895, two each 200585H and 200898D .. |
| 221417 | 11290 | Knife Bar Driving Eccentric with 200382C and 200437C |
| 202890 | 11290 | Knife Bar Driving Eccentric Fork with 200382C and 201464C |
| 201464C | 14103 | Knife Bar Driving Eccentric Fork Position Screw |
| 200382C | 11285 | Knife Bar Driving Eccentric Fork Set Screw |
| 200437C | 12311 | Knife Bar Driving Eccentric Position Screw |
| 200382C | 11285 | Knife Bar Driving Eccentric Set Screw |
| 202891 | 11289 | Knife Bar Driving Shaft Crank with 200694E and 201525E |
| 200694E | 11290 | Knife Bar Driving Shaft Crank Screw Stud |
| 201525E | 11290 | Knife Bar Driving Shaft Crank Screw Stud Nut |
| 202893 | 11290 | Knife Bar Lifting Spring (spiral) .. |
| 202894 | 11290 | " " " " Bracket .. |
| 200585H | 11285 | " " " " " Screw |
| 200485D | 11290 | " " " " " Thumb Screw |
| 202895 | 14107 | Knife Holder |
| 200898D | 14107 | " " Screw |
| 202897 | 14107 | " " Switch-in Handle |
| 200076D | 11290 | " Screw (2) |
| 202898 | 11289 | " Switch-out Handle with two 200403C |

| No. | Plate | Name |
|---------|-------|---|
| 200403C | 14103 | Knife Switch-out Handle Set Screw |
| 202899 | 11290 | " " " Shaft |
| 202900 | 11290 | " " " Spring (spiral) |
| 213770 | 11289 | Needle Bar (hollow) with 200420E, 200595H and 213771 |
| 207072 | 14104 | Needle Bar Bushing (2) |
| 200398C | 14104 | " " " Set Screw (2) .. |
| 204248 | 11292 | " " Connecting Link |
| 200658C | 11292 | " " " " Hinge Screw Stud |
| 201519C | 14107 | Needle Bar Connecting Link Hinge Screw Stud Nut |
| 204249 | 11292 | Needle Bar Connecting Stud with 200072C and 202277 |
| 202277 | --- | Needle Bar Connecting Stud Oil Packing (wick) |
| 200072C | 11292 | Needle Bar Connecting Stud Pinch Screw |
| 213771 | 14107 | Needle Bar Thread Guide |
| 200595H | 14103 | " " " " Screw .. |
| 200420E | 14103 | " Set Screw |
| 207072 | 14104 | Presser Bar Bushing |
| 200398C | 14104 | " " " Set Screw |
| 202339 | 14104 | " " Lifter |
| 200653C | 14104 | " " " Hinge Screw .. |
| 204455 | 11287 | " " Lifting Bracket with 200387C |
| 213667 | 14104 | Presser Bar Lifting Bracket Position Guide with 200075D and 203551 |
| 200075D | 11292 | Presser Bar Lifting Bracket Position Guide Screw |
| 203551 | 11292 | Presser Bar Lifting Bracket Position Guide Screw Bushing |
| 200362C | 12311 | Presser Bar Lifting Bracket Position Guide Set Screw |
| 200387C | 10473 | Presser Bar Lifting Bracket Set Screw |
| 204258 | 11292 | Presser Bar Spring (heavy) |
| 200494B | 14104 | " " Thumb Screw (pressure regulating) |
| 201910 | 11293 | Roller Presser, $\frac{3}{8}$ in. diam., $\frac{1}{4}$ in. face (coarse) with 200551C and 201534H |
| 208497 | --- | Roller Presser Arm |
| 208498 | --- | " " " 208497 with 201910 |

| No. | Plate | Name |
|---------|-------|---|
| 202560 | 11293 | Roller Presser Arm Bracket (swing) |
| 208499 | --- | " " " " 202560 with 200096D and 208498 |
| 200675F | 11293 | Roller Presser Arm Bracket Position Screw Stud |
| 202558 | 11293 | Roller Presser Arm Bracket Spring |
| 202559 | 11293 | " " " " " " Stop |
| 200141F | 11293 | Roller Presser Arm Bracket Spring Stop Screw |
| 200096D | 11293 | Roller Presser Arm Screw |
| 204495 | 11289 | " " Bar |
| 200551C | 11293 | " " Hinge Screw |
| 201534H | 11293 | " " " " Nut |
| 204576 | --- | Roller Presser and Bar complete, Nos. 200675F, 202558, 202559, 204495, 208499 and two 200141F.. |
| 213006 | 11288 | Take-up Cam with 200335C, 200383C, 200430C, 200658C and 201519E ... |
| 203172 | 11292 | Take-up Cam Friction Washer |
| 200430C | 12311 | " " Position Screw |
| 200383C | 12311 | " " " " Check Screw |
| 200335C | 12311 | Take-up Cam Set Screw |
| 203270 | 11292 | " Lever |
| 203291 | --- | " " 203270 with 204263 ... |
| 204263 | 11292 | " " Bearing with 204264 .. |
| 204264 | 11292 | " " " Position Pin ... |
| 200042F | 12311 | " " " Screw |
| 201816 | 11292 | " " Roller |
| 203271 | 11292 | Take-up Lever complete, Nos. 200042F, 201816 and 203291 |
| 244007 | 12349 | Tension Disc |
| 202090 | 12349 | " " Position Pin |
| 223423 | 14107 | " Release Lever |
| 200309E | 12349 | " " " Screw |
| 202075 | 12349 | " " Plunger |
| 223427 | 14107 | " " Slide |
| 204457 | 14104 | " " " Spring |
| 202737 | 14101 | " " " " Adjusting Collar with 200380C |
| 200380C | 14107 | Tension Release Slide Spring Adjusting Collar Set Screw |
| 202407 | 10881 | Tension Spring |
| 200632B | 12349 | " Stud |
| 200397H | 12349 | " " Set Screw |
| 201572B | 10881 | " Thumb Nut |
| 204271 | 12349 | " Washer |

| No. | Plate | Name |
|---------|-------|--|
| 204272 | 12349 | Tension complete, Nos. 200632B, 201572B, 202075, 202407, 204271 and two 244007 |
| 204274 | 12349 | Thread Controller Plate |
| 200577H | 10473 | " " " Screw |
| 202098 | 12349 | " " Roller |
| 204275 | 12349 | " " " Guard |
| 202084 | 12349 | " " " Washer.. |
| 200300C | 12349 | " " " Screw |
| 204276 | 12349 | " " Spring |
| 204333 | 12349 | " " " Guard |
| 200581H | 12349 | " " " " Screw .. |
| 202087 | 12349 | " " " Stop |
| 202088 | 12349 | " " " Stud with 204925 |
| 200366H | 12349 | Thread Controller Spring Stud Set Screw |
| 204925 | 11292 | Thread Controller Spring Stud Washer |
| 205987 | 12349 | Thread Controller complete, Nos. 200300C, 200581H, 202084, 202098, 204274, 204275 and 204333 |
| 204280 | 12349 | Thread Controller and Spring complete, Nos. 204276 and 205987 .. |
| 202412 | 11292 | Thread Guide |
| 202413 | 11292 | " " |
| 202091 | 12349 | " Retainer Sleeve |
| 202092 | 12349 | " " Spring |
| 204058 | 12349 | " " Stud |
| 200368H | 12349 | " " " Set Screw |
| 204059 | 12349 | Thread Retainer complete, Nos. 202091, 202092 and 204058 |
| 211452 | 12058 | Throat Plate, 56 needle hole, for needle sizes 10 and 11, with 200178B, 200587D, 211416 and 211424, trims opposite the needle and .035, .045, .060 and .085 in. to right of seam |
| 213163 | 14102 | Throat Plate Adjusting Lever with 200627E, 201539E, 204387 and two two 200479E |
| 200264D | 11052 | Throat Plate Adjusting Lever Hinge Screw |
| 200479E | 11052 | Throat Plate Adjusting Lever Position Screw |
| 200627E | 11052 | Throat Plate Adjusting Lever Screw Stud |
| 201539E | 11052 | Throat Plate Adjusting Lever Screw Stud Nut |

| No. | Plate | Name |
|---------|-------|--|
| 201556D | 14103 | Throat Plate Adjusting Lever Screw Stud Thumb Nut |
| 213112 | 14101 | Throat Plate Adjusting Lever Screw Stud Thumb Nut Washer Plate |
| 203152 | 14103 | Throat Plate Adjusting Lever Screw Stud Thumb Nut Washer Plate Pin (2) |
| 211424 | 12024 | Throat Plate Knife Follower |
| 200587D | 14103 | " " " " Screw .. |
| 211416 | 14106 | " " " " Spring |
| 200178D | 14103 | " " " " " " Screw |
| 200585H | 11285 | Throat Plate Screw (2) |
| 213162 | 14102 | " " Slide Plate (adjust- able) |
| 204387 | 14101 | Throat Plate Slide Plate Position Stud |
| 200306D | 11052 | Throat Plate Slide Plate Screw (2) |

LIST OF PARTS COMPLETE

FOR

MACHINE No. 29w6

DROP FEED. VERTICAL SEAM TRIMMER

For Leather and Gloves

| No. | Plate | Name |
|---------|-------|---|
| *213143 | - - - | Arm |
| 213921 | 11282 | " Cap |
| 200278H | 12311 | " " Screw |
| 202248 | 11285 | " " " Washer |
| 203089 | 11282 | " " Spool Holder Base |
| 203090 | 11282 | " " " " " " 203089 with 200079H and 204296 |
| 200585H | 11285 | Arm Cap Spool Holder Base Screw |
| 204296 | 11282 | " " " " Wire |
| 200079H | 12311 | " " " " " Hinge Screw |
| 213922 | - - - | Arm Cap and Spool Holder com- plete, Nos. 203090, 213921 and two 200585H |
| 200010E | - - - | Arm Screw (3) |
| 202005 | 11285 | " " Washer (3) |
| 213158 | 11281 | " Shaft |
| 223431 | ----- | " " 213158 with 200244D, 200245D, 213150, 213354, 213654, 213655, 223429, 223430 and two 201528E |
| 204801 | 11282 | Arm Shaft Bushing (back) with 202260 |
| 202260 | ----- | Arm Shaft Bushing (back) Oil Packing (wick) |
| 200338C | 11048 | Arm Shaft Bushing (back) Set Screw |
| 213299 | 11282 | Arm Shaft Bushing (center) with 202260 |
| 202260 | ----- | Arm Shaft Bushing (center) Oil Packing (wick) |
| 200338C | 11048 | Arm Shaft Bushing (center) Set Screw |
| 204802 | 11282 | Arm Shaft Bushing (front) with 202036 and 202260 |
| 202260 | ----- | Arm Shaft Bushing (front) Oil Packing (wick) |

| No. | Plate | Name |
|---------|-------|--|
| 200502B | 11285 | Arm Shaft Bushing (front) Oil Packing Thumb Screw |
| 202036 | 11285 | Arm Shaft Bushing (front) Position Pin |
| 200341c | 11285 | Arm Shaft Bushing (front) Set Screw |
| 204804 | 11281 | Arm Shaft Connection with four 200054E (2) |
| 200054E | 11285 | Arm Shaft Connection Screw |
| 213153 | 11281 | Balance Wheel, 5 1/4 in. diam. (belt groove 2 3/4 in. diam.), with 200328c and 200335c |
| 200062H | 12311 | Balance Wheel Adjusting Screw .. |
| 200328c | 12311 | " " Position Screw |
| 200335c | 12311 | " " Set Screw |
| *213652 | --- | Bed with 203248, 203249, two each 200362c, 200516E, 200840E and 202299 |
| 202258 | 12153 | Bed Hinge Connection (2) |
| 200570E | 12311 | " " " Screw (4) |
| 203329 | 11282 | " Slide (back) |
| 203207 | 11282 | " " (front) |
| 203470 | 11284 | Bobbin |
| *203670 | --- | " Case |
| 203648 | 11284 | " " Latch |
| *202056 | --- | " " " Pin |
| 203473 | 11284 | " " " Plunger |
| 203474 | 11284 | " " " Spring |
| 203499 | 11287 | " " " Lever |
| *203476 | --- | " " " Eccentric |
| 204243 | 11284 | " " " " Position Pin |
| 203506 | 11287 | " " " Fulcrum |
| 200056E | 10884 | " " " " Screw |
| 203478 | 11284 | " " " Slide Stud |
| 203214 | 11284 | " " Tension Spring |
| 200984c | 11284 | " " " " Regulat- ing Screw |
| 200594c | 11284 | Bobbin Case Tension Spring Screw |
| 203216 | --- | " " Washer (cloth) |
| 203669 | 11284 | Bobbin Case complete, Nos. 200594c, 200984c, 202056, 203214, 203216, 203473, 203474, 203648 and 203670 |
| 223421 | 14102 | Face Plate with 200366H, 200368H, 202087, 202090, 204185 and two 200397H |
| 200065c | 11285 | Face Plate Screw (2) |
| 204185 | 11292 | " " Thread Guide |
| 200397H | 12349 | " " " " Set Screw |

| No. | Plate | Name |
|---------|-------|---|
| 223422 | --- | Face Plate complete, Nos. 200309E, 200577H, 202088, 204059, 204272, 204280, 223421 and 223423 |
| 213146 | 11282 | Feed Bar |
| 213229 | --- | " " 213146 with 200641c, 201522E and 213147 |
| 200641c | 11048 | Feed Bar Hinge Screw |
| 201522E | 11285 | " " " " Nut |
| 207651 | 14106 | " Dog |
| 200106E | 12311 | " " Screw (2) |
| 223429 | 11298 | " Driving Eccentric (adjustable) |
| 223430 | 11298 | " " " Adjusting Disc |
| 213150 | 11282 | " " " Flange with 200378c and 200437c |
| 200437c | 12311 | Feed Driving Eccentric Flange Position Screw |
| 200378c | 12311 | Feed Driving Eccentric Flange Set Screw |
| 213655 | 11052 | Feed Driving Eccentric Friction Spring Washer |
| 200245D | 11048 | Feed Driving Eccentric Friction Spring Washer Screw |
| 201528E | 11285 | Feed Driving Eccentric Friction Spring Washer Screw Nut |
| 200244D | 11048 | Feed Driving Eccentric Fulcrum Screw |
| 201528E | 11285 | Feed Driving Eccentric Fulcrum Screw Nut |
| 213147 | 11281 | Feed Driving Rock Shaft |
| 202305 | 11285 | " " " " Center (2) |
| 200043c | 12311 | " " " " " Set Screw (2) |
| 213354 | 11281 | Feed Driving Rock Shaft Connection with 200054E and 202277 |
| 213654 | 11048 | Feed Driving Rock Shaft Connection Collar |
| 202298 | 11048 | Feed Driving Rock Shaft Connection Crank with 200038c |
| 200038c | 11048 | Feed Driving Rock Shaft Connection Crank Pinch Screw |
| 200545c | 11048 | Feed Driving Rock Shaft Connection Hinge Screw |
| 201518E | 11284 | Feed Driving Rock Shaft Connection Hinge Screw Nut |
| 202277 | --- | Feed Driving Rock Shaft Connection Oil Packing (wick) |
| 200054E | 11285 | Feed Driving Rock Shaft Connection Pinch Screw |

| No. | Plate | Name |
|---------|-------|--|
| 213627 | 11285 | Feed Lifting Cam with 202126 |
| 204202 | 11285 | " " " Fork with 200027E |
| 200027E | 11285 | " " " " Pinch Screw |
| 202126 | 11285 | " " " Position Pin |
| 200045E | 11285 | " " " Screw |
| 203236 | 11281 | " " Rock Shaft |
| 203316 | 11281 | " " " 203236 with 203238 |
| 202305 | 11285 | Feed Lifting Rock Shaft Center (2) |
| 200043C | 12311 | " " " " " Set Screw (2) |
| 202276 | 11285 | Feed Lifting Rock Shaft Slide Block |
| 203238 | 11285 | " " " " " " " 202276 with 200243E and 201531E |
| 200243E | 11285 | Feed Lifting Rock Shaft Slide Block Hinge Screw |
| 201531E | 11285 | Feed Lifting Rock Shaft Slide Block Hinge Screw Nut |
| 213161 | 11048 | Feed Regulating Lever with 213657 |
| 200665C | 11048 | " " " Hinge Screw |
| 213656 | 14104 | " " " Spring |
| 213657 | 14104 | " " " " Pin .. |
| *203482 | ----- | Hook (sewing) |
| 203483 | 11287 | " 203482 with 201253E, 201376E and 203251 |
| 203671 | 11287 | Hook and Bobbin Case complete, Nos. 203483 and 203669 |
| 213810 | 11287 | Hook Bevel Gear Socket, 24 teeth |
| 200555H | 11007 | " " " " Screw ... |
| 203242 | 11007 | " " Pinion, 24 teeth, with two 200383C |
| 200383C | 12311 | Hook Bevel Pinion Set Screw |
| 203243 | 11281 | " Counter Shaft |
| 203244 | 11907 | " " " Collar with two 200393C |
| 200393C | 11007 | Hook Counter Shaft Collar Set Screw |
| 203245 | 11007 | Hook Counter Shaft Driving Gear, 44 teeth, with 200362C and 200439C |
| 213155 | ----- | Hook Counter Shaft Driving Gear 203245 with 200045E and 213627.. |
| 200439C | 12311 | Hook Counter Shaft Driving Gear Position Screw |
| 200362C | 12311 | Hook Counter Shaft Driving Gear Set Screw |
| 203246 | 11007 | Hook Counter Shaft Gear, 22 teeth, with two 200383C |
| 200383C | 12311 | Hook Counter Shaft Gear Set Screw |

| No. | Plate | Name |
|---------|-------|---|
| 202299 | ----- | Hook Counter Shaft Oil Packing (wick) |
| 200840E | 11907 | Hook Counter Shaft Oil Packing (wick) Stop Screw |
| 203247 | 11281 | Hook Driving Shaft |
| 203248 | 11288 | " " " Bearing with 202299 |
| 202299 | --- | Hook Driving Shaft Bearing Oil Packing (wick) |
| 202126 | 11285 | Hook Driving Shaft Bearing Posi- tion Pin |
| 200516E | 12311 | Hook Driving Shaft Bearing Screw |
| 203249 | 11907 | " " " Bushing (eccen- tric) |
| 202299 | --- | Hook Driving Shaft Bushing Oil Packing (wick) |
| 200362C | 12311 | Hook Driving Shaft Bushing Set Screw |
| 213141 | 14107 | Hook Driving Shaft Collar with two 200393C |
| 200393C | 11007 | Hook Driving Shaft Collar Set Screw |
| 203251 | 11284 | Hook Gib |
| 201376E | 14104 | " " Hinge Screw |
| 201253E | 14104 | " " Screw |
| 203504 | 11288 | " Saddle with 200056E |
| 200006E | 11007 | " " Screw (2) |
| 225585 | 11007 | " " " Washer (2) |
| 213018 | 14107 | " Washer with 203476 and two 204243 |
| 203680 | 11288 | Hook Saddle complete, Nos. 200555H, 203478, 203499, 203504, 203506, 203761, 213018 and 213810 |
| 228184 | 14108 | Knee Lifter Connection Lever with 202446 |
| 200224H | 11285 | Knee Lifter Connection Lever Hinge Screw |
| 213879 | 14108 | Knee Lifter Connection Lever Lift- ing Rod with 202302 |
| 202302 | 14104 | Knee Lifter Connection Lever Lift- ing Rod Cotter Pin |
| 202446 | 14101 | Knee Lifter Connection Lever Pin |
| 228181 | 14102 | " " Lifting Lever |
| 228183 | --- | " " " " 228181 with 201178H, 201527H and 228182 |
| 228182 | 14102 | Knee Lifter Lifting Lever Bracket |
| 200570E | 12311 | " " " " " Screw |
| 201178H | 14103 | Knee Lifter Lifting Lever Hinge Screw |

| No. | Plate | Name |
|---------|-------|---|
| 201527H | 14103 | Knee Lifter Lifting Lever Hinge Screw Nut |
| 207805 | 10620 | Knife |
| 202887 | 11289 | " Bar |
| 202888 | 11289 | " " 202887 with 202894, 202895, two each 200585H and 200898D .. |
| 221417 | 11290 | Knife Bar Driving Eccentric with 200382C and 200437C |
| 202890 | 11290 | Knife Bar Driving Eccentric Fork with 200382C and 201464C |
| 201464C | 14104 | Knife Bar Driving Eccentric Fork Position Screw |
| 200382C | 11285 | Knife Bar Driving Eccentric Fork Set Screw |
| 200437C | 12311 | Knife Bar Driving Eccentric Position Screw |
| 200382C | 11285 | Knife Bar Driving Eccentric Set Screw |
| 202891 | 11289 | Knife Bar Driving Shaft Crank with 200694F and 201525E |
| 200694F | 11290 | Knife Bar Driving Shaft Crank Screw Stud |
| 201525E | 11290 | Knife Bar Driving Shaft Crank Screw Stud Nut |
| 202893 | 11290 | Knife Bar Lifting Spring (spiral) .. |
| 202894 | 11290 | " " " " Bracket .. |
| 200585H | 11285 | " " " " " Screw |
| 200485D | 11290 | Knife Bar Lifting Spring Thumb Screw |
| 202895 | 14107 | Knife Holder |
| 200898D | 14107 | " " Screw |
| 202897 | 14107 | " " Switch-in Handle |
| 200076D | 11290 | " Screw (2) |
| 202898 | 11289 | " Switch-out Handle with two 200403C |
| 200403C | 14103 | Knife Switch-out Handle Set Screw |
| 202899 | 11290 | " " " Shaft |
| 202900 | 11290 | " " " Spring (Spiral) |
| 213770 | 11289 | Needle Bar (hollow) with 200420F, 200595H and 213771 |
| 207072 | 14104 | Needle Bar Bushing (2) |
| 200398C | 14104 | " " " Set Screw (2) .. |
| 204248 | 11292 | " " Connecting Link |
| 200658C | 11292 | " " " " Hinge Screw Stud |
| 201519E | 14107 | Needle Bar Connecting Link Hinge Screw Stud Nut |

| No. | Plate | Name |
|---------|-------|--|
| 204249 | 11292 | Needle Bar Connecting Stud with 200072C and 202277 |
| 202277 | ----- | Needle Bar Connecting Stud Oil Packing (wick) |
| 200072C | 11292 | Needle Bar Connecting Stud Pinch Screw |
| 213771 | 14107 | Needle Bar Thread Guide |
| 200595H | 14103 | " " " " Screw .. |
| 200420F | 14103 | " Set Screw |
| 207072 | 14104 | Presser Bar Bushing |
| 200398C | 14104 | " " " Set Screw |
| 202339 | 14104 | " " Lifter |
| 200653C | 14104 | " " " Hinge Screw |
| 204455 | 11287 | " " Lifting Bracket with 200387C |
| 213667 | 14104 | Presser Bar Lifting Bracket Position Guide with 200075D and 203551 |
| 200075D | 11292 | Presser Bar Lifting Bracket Position Guide Screw |
| 203551 | 11292 | Presser Bar Lifting Bracket Position Guide Screw Bushing |
| 200362C | 12311 | Presser Bar Lifting Bracket Position Guide Set Screw |
| 200387C | 10473 | Presser Bar Lifting Bracket Set Screw |
| 204258 | 11292 | Presser Bar Spring (heavy) |
| 200494B | 14104 | " " Thumb Screw (pressure regulating) |
| 201910 | 11293 | Roller Presser, $\frac{3}{8}$ in. diam., $\frac{1}{4}$ in. face (coarse), with 200551C and 201534H |
| 208497 | ----- | Roller Presser Arm |
| 208498 | 11293 | " " " 208497 with 201910 |
| 202560 | 11293 | Roller Presser Arm Bracket (swing) |
| 208499 | ----- | " " " " 202560 with 200096D and 208498 |
| 200675F | 11293 | Roller Presser Arm Bracket Position Screw Stud |
| 202558 | 11293 | Roller Presser Arm Bracket Spring |
| 202559 | 11293 | " " " " " Stop |
| 200141F | 11293 | Roller Presser Arm Bracket Spring Stop Screw |
| 200096D | 11293 | Roller Presser Arm Screw |
| 204495 | 11289 | " " Bar |
| 200551C | 11293 | " " Hinge Screw |
| 201534H | 11293 | " " " " Nut |

| No. | Plate | Name |
|---------|-------|---|
| 204576 | — | Roller Presser and Bar complete, Nos. 200675F, 202558, 202559, 204495, 208499 and two 200141F.. |
| 213006 | 11288 | Take-up Cam with 200335c, 200383c, 200430c, 200658c and 201519E .. |
| 203172 | 11292 | Take-up Cam Friction Washer |
| 200430c | 12311 | " " Position Screw |
| 200383c | 12311 | " " " " Check Screw |
| 200335c | 12311 | Take-up Cam Set Screw |
| 203270 | 11292 | " Lever |
| 203291 | — | " " 203270 with 204263 .. |
| 204263 | 11292 | " " Bearing with 204264 .. |
| 204264 | 11292 | " " " Position Pin ... |
| 200042F | 12311 | " " " Screw |
| 201816 | 11292 | " " Roller |
| 203271 | 11292 | Take-up Lever complete, Nos. 200042F, 201816 and 203291 |
| 244007 | 12349 | Tension Disc |
| 202090 | 12349 | " " Position Pin |
| 223423 | 14107 | " Release Lever |
| 200309E | 12349 | " " " Screw |
| 202075 | 12349 | " " Plunger |
| 223427 | 14107 | " " Slide |
| 204457 | 14101 | " " " Spring |
| 202737 | 14101 | " " " " Adjusting Collar with 200380c |
| 200380c | 14107 | Tension Release Slide Spring Adjusting Collar Set Screw |
| 202407 | 10881 | Tension Spring |
| 200632B | 12349 | " Stud |
| 200397H | 12349 | " " Set Screw |
| 201572B | 10881 | " Thumb Nut |
| 204271 | 12349 | " Washer |
| 204272 | 12349 | Tension complete, Nos. 200632B, 201572B, 202075, 202407, 204271 and two 244007 |
| 204274 | 12349 | Thread Controller Plate |
| 200577H | 10473 | " " " Screw |
| 202098 | 12349 | " " Roller |
| 204275 | 12349 | " " " Guard |
| 202084 | 12349 | " " " " Washer |
| 200300c | 12349 | " " " " Screw |
| 204276 | 12349 | " " Spring |
| 204333 | 12349 | " " " Guard |
| 200581H | 12349 | " " " " Screw |
| 202087 | 12349 | " " " Stop |
| 202088 | 12349 | " " " Stud with 204925 |

| No. | Plate | Name |
|---------|-------|--|
| 200366H | 12349 | Thread Controller Spring Stud Set Screw |
| 204925 | 11292 | Thread Controller Spring Stud Washer |
| 205987 | 12349 | Thread Controller complete, Nos. 200300c, 200581H, 202084, 202098, 204274, 204275 and 204333 |
| 204280 | 12349 | Thread Controller and Spring complete, Nos. 204276 and 205987 .. |
| 202412 | 11292 | Thread Guide |
| 202413 | 11292 | " " |
| 202091 | 12349 | " Retainer Sleeve |
| 202092 | 12349 | " " Spring |
| 204058 | 12349 | " " Stud |
| 200368H | 12349 | " " " Set Screw |
| 204059 | 12349 | Thread Retainer complete, Nos. 202091, 202092 and 204058 |
| 211420 | 12064 | Throat Plate, 56 needle hole, for needle sizes 10 and 11, with 200178D, 200587D, 211416 and 211424, trims opposite the needle and .035, .045, .060 and .085 in. to right of seam |
| 213163 | 14102 | Throat Plate Adjusting Lever with 200627E, 201539E, 204387 and two 200479F |
| 200264D | 11052 | Throat Plate Adjusting Lever Hinge Screw |
| 200479F | 11052 | Throat Plate Adjusting Lever Position Screw |
| 200627E | 11052 | Throat Plate Adjusting Lever Screw Stud |
| 201539E | 11052 | Throat Plate Adjusting Lever Screw Stud Nut |
| 201556D | 14103 | Throat Plate Adjusting Lever Screw Stud Thumb Nut |
| 213112 | 14101 | Throat Plate Adjusting Lever Screw Stud Thumb Nut Washer Plate |
| 203152 | 14103 | Throat Plate Adjusting Lever Screw Stud Thumb Nut Washer Plate Pin (2) |
| 211424 | 12024 | Throat Plate Knife Follower |
| 200587D | 14103 | " " " " Screw |
| 211416 | 14106 | " " " " Spring |
| 200178D | 14103 | " " " " " Screw |

| No. | Plate | Name |
|---------|-------|---|
| 200585R | 11285 | Throat Plate Screw (2) |
| 213162 | 14102 | " " Slide Plate (adjust- able) |
| 204387 | 14101 | Throat Plate Slide Plate Position Stud |
| 200306D | 11052 | Throat Plate Slide Plate Screw (2) |

MACHINE No. 29w11

Same as Machine No. 29w2 with the following exceptions:

| No. | Plate | Name |
|---------|-------|---|
| 223440 | ---- | Face Plate complete, Nos. 200309E, 200577U, 202088, 204059, 204280, 223421, 223423 and 223439, in place of 223422 |
| 213007 | 14101 | Feed Lifting Cam with 202126, in place of 213627 |
| *223434 | ---- | Hook (sewing), in place of 203463 |
| 223435 | 14101 | " 223434 with 201253E, 201376E and 203251, in place of 203464 .. |
| 223436 | ---- | Hook and Bobbin Case complete, Nos. 203217 and 223435, in place of 203465 |
| 213157 | ---- | Hook Counter Shaft Driving Gear 203245 with 200045E and 213007, in place of 213155 |
| 223437 | 14102 | Hook Saddle complete, Nos. 200555U, 203241, 203252, 203718 and 223436, in place of 203466 .. |
| 202554 | 14101 | Presser Bar Lifter, in place of 202339 |
| 201907 | 11293 | Roller Presser, 1½ in. diam., ½ in. face (fine), with 200548C and 201534U, in place of 201910 |
| 202839 | 11293 | Roller Presser Arm, in place of 204328 |
| 204569 | 11293 | Roller Presser Arm 202839 with 201907, in place of 204570 |
| 204436 | ---- | Roller Presser Arm Bracket 202560 with 200096D and 204569, in place of 204575 |
| 204437 | ---- | Roller Presser and Bar complete, Nos. 200675C, 202558, 202559, 204436, 204495 and two 200141E, in place of 204576 |
| 223438 | 14101 | Tension Spring, in place of 202407 |
| 223439 | 14107 | Tension complete, Nos. 200632B, 201572B, 202075, 204271, 223438 and two 202402, in place of 204272 |
| 211454 | 12058 | Throat Plate, 50 needle hole, for needle sizes 14 and 15, with 200178D, 200587D, 211416 and 211424, trims opposite the needle .060 and .085 in. to right of seam, in place of 211452 |

LIST OF PARTS COMPLETE

FOR

MACHINE No. 29w14

WHEEL FEED. VERTICAL SEAM TRIMMER

For Leather and Gloves

| No. | Plate | Name |
|---------|-------|---|
| *213143 | — | Arm |
| 213921 | 11282 | " Cap |
| 200278u | 12311 | " " Screw |
| 202248 | 11285 | " " " Washer |
| 203089 | 11282 | " " Spool Holder Base |
| 203090 | 11282 | " " " " " 203089 with 200079u and 204296 |
| 200585u | 11285 | Arm Cap Spool Holder Base Screw |
| 204296 | 11282 | " " " " Wire |
| 200079u | 12311 | " " " " " Hinge Screw |
| 213922 | — | Arm Cap Spool Holder complete, Nos. 203090, 213921 and two 200585u |
| 200010E | — | Arm Screw (3) |
| 202005 | 11285 | " " Washer (3) |
| 213158 | 11281 | " Shaft |
| 223431 | — | " " 213158 with 200244d, 200245d, 213150, 213354, 213654, 213655, 223429, 223430 and two 201528E |
| 204801 | 11282 | Arm Shaft Bushing (back) with 202260 |
| 202260 | — | Arm Shaft Bushing (back) Oil Packing (wick) |
| 200338c | 11048 | Arm Shaft Bushing (back) Set Screw |
| 213299 | 11282 | Arm Shaft Bushing (center) with 202260 |
| 202260 | — | Arm Shaft Bushing (center) Oil Packing (wick) |
| 200338c | 11048 | Arm Shaft Bushing (center) Set Screw |
| 204802 | 11282 | Arm Shaft Bushing (front) with 202036 and 202260 |
| 202260 | — | Arm Shaft Bushing (front) Oil Packing (wick) |

| No. | Plate | Name |
|---------|-------|--|
| 200502b | 11285 | Arm Shaft Bushing (front) Oil Packing Thumb Screw |
| 202036 | 11285 | Arm Shaft Bushing (front) Posi- tion Pin |
| 200341c | 11285 | Arm Shaft Bushing (front) Set Screw |
| 204804 | 11281 | Arm Shaft Connection with four 200054E (2) |
| 200054E | 11285 | Arm Shaft Connection Screw |
| 213153 | 11281 | Balance Wheel, 5 $\frac{1}{4}$ in. diam. (belt groove 2 $\frac{3}{4}$ in. diam.), with 200328c and 200335c |
| 200062u | 12311 | Balance Wheel Adjusting Screw .. |
| 200328c | 12311 | " " Position Screw |
| 200335c | 12311 | " " Set Screw |
| *213868 | — | Bed with 203248, 203249, two each 200362c, 200516E, 200840E and 202299 |
| 202258 | 12153 | Bed Hinge Connection (2) |
| 200570E | 12311 | " " " Screw (4) |
| 203329 | 11282 | " Slide (back) |
| 203207 | 11282 | " " (front) |
| 203470 | 11284 | Bobbin |
| *203670 | — | " Case |
| 203648 | 11284 | " " Latch |
| *202056 | — | " " " Pin |
| 203473 | 11284 | " " " Plunger |
| 203474 | 11284 | " " " Spring |
| 203499 | 11287 | " " Lever |
| *203476 | — | " " " Eccentric |
| 204243 | 11284 | " " " Position Pin |
| 203506 | 11287 | " " " Fulcrum |
| 200056E | 10884 | " " " " Screw |
| 203478 | 11284 | " " " Slide Stud |
| 203214 | 11284 | " " Tension Spring |
| 200984c | 11284 | " " " " Regulat- ing Screw |
| 200594c | 11284 | Bobbin Case Tension Spring Screw |
| 203216 | — | " " Washer (cloth) |
| 203669 | 11284 | Bobbin Case complete. Nos. 200594c, 200984c, 202056, 203214, 203216, 203473, 203474, 203648 and 203670 |
| 223421 | — | Face Plate with 200366u, 200368u, 202087, 202090, 204185 and two 200397u |
| 200065c | 11285 | Face Plate Screw (2) |
| 204185 | 11292 | " " Thread Guide |
| 200397u | 12349 | " " " " Set Screw |

| No. | Plate | Name |
|---------|-------|---|
| 223422 | — | Face Plate complete, Nos. 200309E, 200577H, 202088, 204059, 204272, 204280, 223421 and 223423 |
| 223429 | 11298 | Feed Driving Eccentric (adjustable) |
| 223430 | 11298 | " " " Adjusting Disc |
| 213150 | 11282 | " " " Flange with 200378c and 200437c |
| 200437c | 12311 | Feed Driving Eccentric Flange Position Screw |
| 200378c | 12311 | Feed Driving Eccentric Flange Set Screw |
| 213655 | 11048 | Feed Driving Eccentric Friction Spring Washer |
| 200245D | 11048 | Feed Driving Eccentric Friction Spring Washer Screw |
| 201528E | 11285 | Feed Driving Eccentric Friction Spring Washer Screw Nut |
| 200244D | 11048 | Feed Driving Eccentric Fulcrum Screw |
| 201528E | 11285 | Feed Driving Eccentric Fulcrum Screw Nut |
| 213863 | 11281 | Feed Driving Rock Shaft |
| 202305 | 11285 | " " " " Center (2) |
| 200043c | 12311 | " " " " " Set Screw (2) |
| 213354 | 11281 | Feed Driving Rock Shaft Connection with 200054E and 202277 .. |
| 213654 | 11048 | Feed Driving Rock Shaft Connection Collar |
| 202298 | 11048 | Feed Driving Rock Shaft Connection Crank with 200038c |
| 200038c | 11048 | Feed Driving Rock Shaft Connection Crank Pinch Screw |
| 200545c | 11048 | Feed Driving Rock Shaft Connection Hinge Screw |
| 201518E | 11285 | Feed Driving Rock Shaft Connection Hinge Screw Nut |
| 202277 | — | Feed Driving Rock Shaft Connection Oil Packing (wick) |
| 200054E | 11285 | Feed Driving Rock Shaft Connection Pinch Screw |
| 213161 | 11048 | Feed Regulating Lever with 213657 |
| 200665c | 11048 | " " " Hinge Screw |
| 213656 | 14104 | " " " Spring |
| 213657 | 14104 | " " " " Pin .. |
| 204429 | 11288 | " Wheel |
| 223010 | 14103 | " " Driver with two each 201209F and 201515E |
| 201209F | 14103 | Feed Wheel Driver Clutch Stud ... |
| 201515E | 14103 | " " " " " Nut |

| No. | Plate | Name |
|---------|-------|--|
| 223011 | — | Feed Wheel Driver and Clutch complete, Nos. 200263F, 200266D, 201528E, 204308, 204310 and 223010 |
| 204308 | 14104 | Feed Wheel Driver Crank with two 200383c |
| 200266D | 11286 | Feed Wheel Driver Crank Hinge Screw |
| 200383c | 12311 | Feed Wheel Driver Crank Set Screw |
| 204335 | 11286 | Feed Wheel Driver Guide |
| 200162D | 11286 | " " " " Screw .. |
| 204310 | 11286 | " " " Link |
| 200263F | 11286 | " " " " Hinge Screw |
| 201528E | 11285 | " " " " " " Nut |
| 223043 | — | Feed Wheel Driver Spring (spiral) |
| 204190 | 11292 | " " " " " Hook (upper) |
| 204336 | 14512 | Feed Wheel Frame with 200383c, 204190 and 204321 |
| 204424 | 14101 | Feed Wheel Frame Adjusting Eccentric |
| 200347c | 14103 | Feed Wheel Frame Adjusting Eccentric Set Screw |
| 200383c | 12311 | Feed Wheel Frame Set Screw ... |
| 204337 | 11281 | " " " " Shaft |
| 202305 | 11285 | " " " " Center (2) |
| 200043c | 12311 | " " " " " " Set Screw (2) |
| 204317 | 11286 | Feed Wheel Friction Spring |
| 200162D | 11286 | " " " " " Screw |
| 204433 | — | Feed Wheel Frame complete, Nos. 204317, 204320, 204335, 204336, 204429, 206047 and four 200162D .. |
| 206047 | 11286 | Feed Wheel Retaining Clutch with 204189 |
| 204320 | 11286 | Feed Wheel Retaining Clutch Spring |
| 204189 | 11292 | Feed Wheel Retaining Clutch Spring Hook |
| 204321 | 11286 | Feed Wheel Retaining Clutch Spring Pin |
| 200162D | 11286 | Feed Wheel Retaining Screw |
| *203482 | — | Hook (sewing) |
| 203483 | 11287 | " 203482 with 201253F, 201376F and 203251 |
| 203671 | 11287 | Hook and Bobbin Case complete, Nos. 203483 and 203669 |

| No. | Plate | Name |
|---------|-------|--|
| 213810 | 11287 | Hook Bevel Gear Socket, 24 teeth.. |
| 200555H | 11007 | " " " " Screw |
| 203242 | 11007 | " " Pinion, 24 teeth, with two 200383c |
| 200383c | 12311 | Hook Bevel Pinion Set Screw |
| 203243 | 11281 | " Counter Shaft |
| 203244 | 11007 | " " " Collar with two 200393c |
| 200393c | 11007 | Hook Counter Shaft Collar Set Screw |
| 203245 | 11007 | Hook Counter Shaft Driving Gear, 44 teeth, with 200362c and 200439c |
| 200439c | 12311 | Hook Counter Shaft Driving Gear Position Screw |
| 200362c | 12311 | Hook Counter Shaft Driving Gear Set Screw |
| 203246 | 11007 | Hook Counter Shaft Gear, 22 teeth, with two 200383c |
| 200383c | 12311 | Hook Counter Shaft Gear Set Screw |
| 202299 | — | " " " Oil Packing (wick) |
| 200840E | 11007 | Hook Counter Shaft Oil Packing (wick) Stop Screw |
| 203247 | 11281 | Hook Driving Shaft |
| 203248 | 11288 | " " " Bearing with 202299 |
| 202299 | — | Hook Driving Shaft Bearing Oil Packing (wick) |
| 202126 | 11285 | Hook Driving Shaft Bearing Posi- tion Pin |
| 200516E | 12311 | Hook Driving Shaft Bearing Screw |
| 203249 | 11007 | " " " Bushing (eccen- tric) |
| 202299 | — | Hook Driving Shaft Bushing Oil Packing (wick) |
| 200362c | 12311 | Hook Driving Shaft Bushing Set Screw |
| 213141 | 14107 | Hook Driving Shaft Collar with two 200393c |
| 200393c | 11007 | Hook Driving Shaft Collar Set Screw |
| 203251 | 11284 | Hook Gib |
| 201376F | 14104 | " " Hinge Screw |
| 201253F | 14104 | " " Screw |
| 203504 | 11288 | " Saddle with 200056E |
| 200006E | 11007 | " " Screw (2) |
| 225585 | 11007 | " " " Washer (2) |
| 213018 | 14107 | " Washer with 203476 and two 204243 |

| No. | Plate | Name |
|---------|-------|---|
| 203680 | 11288 | Hook Saddle complete, Nos. 200555H, 203478, 203499, 203504, 203506, 203671, 213018 and 213810 |
| 228184 | 14108 | Knee Lifter Connection Lever with 202446 |
| 200224H | 11285 | Knee Lifter Connection Lever Hinge Screw |
| 213879 | 14108 | Knee Lifter Connection Lever Lift- ing Rod with 202302 |
| 202302 | 14104 | Knee Lifter Connection Lever Lift- ing Rod Cotter Pin |
| 202446 | 14104 | Knee Lifter Connection Lever Pin |
| 228181 | 14102 | " " Lifting Lever |
| 228183 | — | " " " " 228181 with 201178H, 201527H and 228182 |
| 228182 | 14102 | Knee Lifter Lifting Lever Bracket |
| 200570E | 12311 | " " " " " " Screw |
| 201178H | 14103 | Knee Lifter Lifting Lever Hinge Screw |
| 201527H | 14103 | Knee Lifter Lifting Lever Hinge Screw Nut |
| 207805 | 10620 | Knife |
| 202887 | 11289 | " Bar |
| 202888 | 11289 | " " 202887 with 202894, 202895, two each 200585H and 200898D |
| 221417 | 11290 | Knife Bar Driving Eccentric with 200382c and 200437c |
| 202890 | 11290 | Knife Bar Driving Eccentric Fork with 200382c and 201464c |
| 201464c | 14103 | Knife Bar Driving Eccentric Fork Position Screw |
| 200382c | 11285 | Knife Bar Driving Eccentric Fork Set Screw |
| 200437c | 12311 | Knife Bar Driving Eccentric Posi- tion Screw |
| 200382c | 11285 | Knife Bar Driving Eccentric Set Screw |
| 202891 | 11289 | Knife Bar Driving Shaft Crank with 200694E and 201525E |
| 200694E | 11290 | Knife Bar Driving Shaft Crank Screw Stud |
| 201525E | 11290 | Knife Bar Driving Shaft Crank Screw Stud Nut |
| 202893 | 11290 | Knife Bar Lifting Spring (spiral) |
| 202894 | 11290 | " " " " Bracket |
| 200585H | 11285 | " " " " " Screw |

| No. | Plate | Name |
|---------|-------|--|
| 200485D | 11290 | Knife Bar Lifting Spring Thumb Screw |
| 202895 | 14107 | Knife Holder |
| 200898D | 14107 | " " Screw |
| 202897 | 14107 | " " Switch-in Handle |
| 200076D | 11290 | " Screw (2) |
| 202898 | 11289 | " Switch-out Handle with two 200403c |
| 200403C | 14103 | Knife Switch-out Handle Set Screw |
| 202899 | 11290 | " " " Shaft |
| 202900 | 11290 | " " " Spring (spiral) |
| 213770 | 11289 | Needle Bar (hollow) with 200420F, 200595H and 213771 |
| 207072 | 14104 | Needle Bar Bushing (2) |
| 200398C | 14104 | " " " Set Screw (2) .. |
| 204248 | 11292 | " " Connecting Link |
| 200658C | 11292 | " " " " Hinge Screw Stud |
| 201519E | 11292 | Needle Bar Connecting Link Hinge Screw Stud Nut |
| 204249 | 11292 | Needle Bar Connecting Stud with 200072c and 202277 |
| 202277 | — | Needle Bar Connecting Stud Oil Packing (wick) |
| 200072C | 11292 | Needle Bar Connecting Stud Pinch Screw |
| 213771 | 14107 | Needle Bar Thread Guide |
| 200595H | 14103 | " " " " Screw .. |
| 200420F | 14103 | " Set Screw |
| 207072 | 14104 | Presser Bar Bushing |
| 200398C | 14104 | " " " Set Screw |
| 202339 | 14104 | " " " Lifter |
| 200653C | 14104 | " " " Hinge Screw ... |
| 204455 | 14104 | " " " Lifting Bracket with 200387c |
| 213667 | 14104 | Presser Bar Lifting Bracket Position Guide with 200075D and 203551 |
| 200075D | 11292 | Presser Bar Lifting Bracket Position Guide Screw |
| 203551 | 11292 | Presser Bar Lifting Bracket Position Guide Screw Bushing |
| 200362C | 12311 | Presser Bar Lifting Bracket Position Guide Set Screw |
| 200387C | 10473 | Presser Bar Lifting Bracket Set Screw |
| 204258 | 11292 | Presser Bar Spring (heavy) |
| 200494B | 14104 | " " Thumb Screw (pressure regulating) |

| No. | Plate | Name |
|---------|-------|---|
| 201910 | 11293 | Roller Presser, $\frac{1}{2}$ in. diam., $\frac{1}{8}$ in. face (coarse) with 200551c and 201534H |
| 208497 | — | Roller Presser Arm |
| 208498 | — | " " " 208497 with 201910 |
| 202560 | 11293 | Roller Presser Arm Bracket (swing) |
| 208499 | — | Roller Presser Arm Bracket 202560 with 200096D and 208498 |
| 200675F | 11293 | Roller Presser Arm Bracket Position Screw Stud |
| 202558 | 11293 | Roller Presser Arm Bracket Spring |
| 202559 | 11293 | " " " " " " Stop |
| 200141F | 11293 | Roller Presser Arm Bracket Spring Stop Screw |
| 200096D | 11293 | Roller Presser Arm Screw |
| 204495 | 11289 | " " Bar |
| 200551C | 11293 | " " Hinge Screw |
| 201534H | 11293 | " " " " " Nut |
| 204576 | — | Roller Presser and Bar complete, Nos. 200675F, 202558, 202559, 204495, 208499 and two 200141F .. |
| 213006 | 11288 | Take-up Cam with 200335c, 200383c, 200430c, 200658c and 201519E .. |
| 203172 | 11292 | Take-up Cam Friction Washer ... |
| 200430C | 12311 | " " Position Screw |
| 200383C | 12311 | " " " " " Check Screw |
| 200335C | 12311 | Take-up Cam Set Screw |
| 203270 | 11292 | " Lever |
| 203291 | — | " " 203270 with 204263 .. |
| 204263 | 11292 | " " Bearing with 204264 .. |
| 204264 | 11292 | " " " Position Pin ... |
| 200042F | 12311 | " " " Screw |
| 201816 | 11292 | " " Roller |
| 203271 | 11292 | Take-up Lever complete, Nos. 200042F, 201816 and 203291 |
| 244007 | 12349 | Tension Disc |
| 202090 | 12349 | " " Position Pin |
| 223423 | 14107 | " Release Lever |
| 200309E | 12349 | " " " Screw |
| 202075 | 12349 | " " Plunger |
| 223427 | 14107 | " " Slide |
| 204457 | 14104 | " " " Spring |
| 202737 | 14101 | " " " " Adjusting Collar with 200380c |
| 200380C | 14107 | Tension Release Slide Spring Adjusting Collar Set Screw |

| No. | Plate | Name |
|---------|-------|---|
| 202407 | 10881 | Tension Spring |
| 200632b | 12349 | " Stud |
| 200397H | 12349 | " " Set Screw |
| 201572b | 10881 | " Thumb Nut |
| 204271 | 12349 | " Washer |
| 204272 | 12349 | Tension complete, Nos. 200632b, 201572b, 202075, 202407, 204271 and two 244007 |
| 204274 | 12349 | Thread Controller Plate |
| 200577H | 10473 | " " " Screw |
| 202098 | 12349 | " " Roller |
| 204275 | 12349 | " " Guard |
| 202084 | 12349 | " " " Washer |
| 200300c | 12349 | " " " Screw |
| 204276 | 12349 | " " Spring |
| 204333 | 12349 | " " " Guard |
| 200581H | 12349 | " " " " Screw.. |
| 202087 | 12349 | " " " Stop |
| 202088 | 12349 | " " " Stud with 204925 |
| 200366H | 12349 | Thread Controller Spring Stud Set Screw |
| 204925 | 11292 | Thread Controller Spring Stud Washer |
| 205987 | 12349 | Thread Controller complete, Nos. 200300c, 200581H, 202084, 202098, 204274, 204275 and 204333 |
| 204280 | 12349 | Thread Controller and Spring com- plete, Nos. 204276 and 205987 ... |
| 202412 | 11292 | Thread Guide |
| 202413 | 11292 | " " |
| 202091 | 12349 | " Retainer Sleeve |
| 202092 | 12349 | " " Spring |
| 204058 | 12349 | " " Stud |
| 200368H | 12349 | " " " Set Screw |
| 204059 | 12349 | Thread Retainer complete, Nos. 202091, 202092 and 204058 |
| 211485 | 12064 | Throat Plate, 60 needle hole, for needle sizes 8 and 9, with 200178b, 200587b, 211416 and 211424, trims opposite the needle and .028, .035, .045, .060 and .085 in. to right of seam |
| 213163 | 14102 | Throat Plate Adjusting Lever with 200627e, 201539e, 204387 and two 200479e |
| 200264b | 11052 | Throat Plate Adjusting Lever Hinge Screw |
| 200479e | 11052 | Throat Plate Adjusting Lever Posi- tion Screw |

| No. | Plate | Name |
|---------|-------|--|
| 200627e | 11052 | Throat Plate Adjusting Lever Screw Stud |
| 201539e | 11052 | Throat Plate Adjusting Lever Screw Stud Nut |
| 201556b | 14103 | Throat Plate Adjusting Lever Screw Stud Thumb Nut |
| 213112 | 14101 | Throat Plate Adjusting Lever Screw Stud Thumb Nut Washer Plate |
| 203152 | 14103 | Throat Plate Adjusting Lever Screw Stud Thumb Nut Washer Plate Pin (2) |
| 211424 | 12024 | Throat Plate Knife Follower |
| 200587b | 14103 | " " " " Screw .. |
| 211416 | 14106 | " " " " Spring |
| 200178b | 14103 | " " " " " " Screw |
| 200585H | 11285 | Throat Plate Screw (2) |
| 213162 | 14102 | " " Slide Plate (adjust- able) |
| 204387 | 14101 | Throat Plate Slide Plate Position Stud |
| 200306b | 11052 | Throat Plate Slide Plate Screw (2) |

LIST OF PARTS COMPLETE
FOR
MACHINE No. 29w15

DROP FEED. OBLIQUE UNDEREDGE TRIMMER

For Leather

| No. | Plate | Name |
|---------|-------|---|
| *213166 | --- | Arm |
| 213921 | 11282 | " Cap |
| 200278H | 12311 | " " Screw |
| 202248 | 11285 | " " " Washer |
| 203089 | 11282 | " " Spool Holder Base |
| 203090 | 11282 | " " " " " 203089 with 200079H and 204296 |
| 200585H | 11285 | Arm Cap Spool Holder Base Screw |
| 204296 | 11282 | " " " " Wire |
| 200079H | 12311 | " " " " " Hinge Screw |
| 213922 | --- | Arm Cap and Spool Holder complete, Nos. 203090, 213921 and two 200585H |
| 200010E | --- | Arm Screw (3) |
| 202005 | 11285 | " " Washer (3) |
| 213158 | 11281 | " Shaft |
| 223431 | --- | " " 213158 with 200244D, 200245D, 213150, 213354, 213654, 213655, 223429, 223430 and two 201528E |
| 204801 | 11282 | Arm Shaft Bushing (back) with 202260 |
| 202260 | --- | Arm Shaft Bushing (back) Oil Packing (wick) |
| 200338c | 11048 | Arm Shaft Bushing (back) Set Screw |
| 213299 | 11282 | Arm Shaft Bushing (center) with 202260 |
| 202260 | --- | Arm Shaft Bushing (center) Oil Packing (wick) |
| 200338c | 11048 | Arm Shaft Bushing (center) Set Screw |
| 204802 | 11282 | Arm Shaft Bushing (front) with 202036 and 202260 |

| No. | Plate | Name |
|---------|-------|---|
| 202260 | --- | Arm Shaft Bushing (front) Oil Packing (wick) |
| 200502B | 11285 | Arm Shaft Bushing (front) Oil Packing Thumb Screw |
| 202036 | 11285 | Arm Shaft Bushing (front) Position Pin |
| 200341c | 11285 | Arm Shaft Bushing (front) Set Screw |
| 204804 | 11281 | Arm Shaft Connection with four 200054E (2) |
| 200054E | 11285 | Arm Shaft Connection Screw |
| 213153 | 11281 | Balance Wheel, 5 1/2 in. diam. (belt groove 2 3/4 in. diam.), with 200328c and 200355c |
| 200062H | 12311 | Balance Wheel Adjusting Screw |
| 200328c | 12311 | " " Position Screw |
| 200335c | 12311 | " " Set Screw |
| *213652 | --- | Bed with 203248, 203249, two each 200362c, 200516E, 200840E and 202299 |
| 202258 | 12153 | Bed Hinge Connection (2) |
| 200570E | 12311 | " " " " Screw (4) |
| 203329 | 11282 | " Slide (back) |
| 203207 | 11282 | " " (front) |
| 203208 | 11284 | Bobbin |
| 203210 | 11284 | " Case Base with 202056, 203211 to 203213 and 203216 |
| 203211 | 11284 | Bobbin Case Base Latch |
| *202056 | --- | " " " " Pin |
| 203212 | 11284 | " " " " Plunger |
| 203213 | 11284 | " " " " Spring |
| 203209 | 11284 | " " Cap with 200984c, 203214, 203215 and two 200594c |
| 203214 | 11284 | Bobbin Case Tension Spring |
| 200984c | 11284 | " " " " " Regulat- ing Screw |
| 200594c | 11284 | Bobbin Case Tension Spring Screw |
| 203215 | 11284 | " " Thread Guide |
| 200594c | 11284 | " " " " " Screw |
| 203216 | --- | " " Washer (cloth) |
| 203217 | 11284 | Bobbin Case complete, Nos. 203209 and 203210 |
| 201353 | 11283 | Bracket (underedge) with 204411 |
| 200517D | 11290 | " Screw (2) |
| 213629 | 11283 | Bracket (underedge) complete, Nos. 200047D, 200118E, 200577H, 200888, 202603, 204233, 204353, 204361, 204363 to 204365, 204368, 204372, 204373, 213772, 213774, 213777, 214053 and two 200028B |

From the library of: Diamond Needle Corp

| No. | Plate | Name |
|---------|-------|---|
| 223421 | 14102 | Face Plate with 200366u, 200368u, 202087, 202090, 204185 and two 200397u |
| 200065c | 11285 | Face Plate Screw (2) |
| 204185 | 11292 | " " Thread Guide |
| 200397u | 12349 | " " " " Set Screw |
| 223422 | --- | Face Plate complete, Nos. 200309f, 200577u, 202088, 204059, 204272, 204280, 223421 and 223423 |
| 213146 | 11282 | Feed Bar |
| 213229 | --- | " " 213146 with 200641c, 201522e and 213147 |
| 200641c | 11048 | Feed Bar Hinge Screw |
| 201522e | 11285 | " " " " nut |
| 207651 | 14106 | " Dog |
| 200106e | 12311 | " " Screw (2) |
| 223429 | 11298 | " Driving Eccentric (adjustable) |
| 223430 | 11298 | " " " Adjusting Disc |
| 213150 | 11282 | " " " Flange with 200378c and 200437c |
| 200437c | 12311 | Feed Driving Eccentric Flange Position Screw |
| 200378c | 12311 | Feed Driving Eccentric Flange Set Screw |
| 213655 | 11048 | Feed Driving Eccentric Friction Spring Washer |
| 200245b | 11048 | Feed Driving Eccentric Friction Spring Washer Screw |
| 201528e | 11285 | Feed Driving Eccentric Friction Spring Washer Screw Nut |
| 200244b | 11048 | Feed Driving Eccentric Fulcrum Screw |
| 201528e | 11285 | Feed Driving Eccentric Fulcrum Screw Nut |
| 213147 | 11281 | Feed Driving Rock Shaft |
| 202305 | 11285 | " " " " Center (2) |
| 200043c | 12311 | " " " " " Set Screw (2) |
| 213354 | 11281 | Feed Driving Rock Shaft Connection with 200054e and 202277 |
| 213654 | 11048 | Feed Driving Rock Shaft Connection Collar |
| 202298 | 11048 | Feed Driving Rock Shaft Connection Crank with 200038e |
| 200038c | 11048 | Feed Driving Rock Shaft Connection Crank Pinch Screw |
| 200545c | 11048 | Feed Driving Rock Shaft Connection Hinge Screw |
| 201518e | 11285 | Feed Driving Rock Shaft Connection Hinge Screw Nut |

| No. | Plate | Name |
|---------|-------|--|
| 202277 | --- | Feed Driving Rock Shaft Connection Oil Packing (wick) |
| 200054e | 11285 | Feed Driving Rock Shaft Connection Pinch Screw |
| 213627 | 11285 | Feed Lifting Cam with 202126 |
| 204202 | 11285 | " " " Fork with 200027e |
| 200027e | 11285 | " " " " Pinch Screw |
| 202126 | 11285 | " " " " Position Pin ... |
| 200045e | 11285 | " " " " Screw |
| 203236 | 11281 | " " " Rock Shaft |
| 203316 | 11281 | " " " " 203236 with 203238 |
| 202305 | 11285 | Feed Lifting Rock Shaft Center (2) |
| 200043c | 12311 | " " " " " Set Screw (2) |
| 202276 | 11285 | Feed Lifting Rock Shaft Slide Block |
| 203238 | 11285 | " " " " " " |
| 200243e | 11285 | 202276 with 200243e and 201531e |
| 200243e | 11285 | Feed Lifting Rock Shaft Slide Block Hinge Screw |
| 201531e | 11285 | Feed Lifting Rock Shaft Slide Block Hinge Screw Nut |
| 213161 | 11048 | Feed Regulating Lever with 213657 |
| 200665c | 11048 | " " " " Hinge Screw |
| 213656 | 14104 | " " " " Spring |
| 213657 | 14104 | " " " " " Pin .. |
| 204356 | 11291 | Guide Finger |
| 204357 | 10473 | " " " " " Clamp with 200103b and 200136e |
| 204358 | 10473 | Guide Finger Clamp Bar |
| 204359 | 10473 | " " " " " Carrier with 200875 |
| 213777 | - - | Guide Finger Clamp Bar Carrier 204359 with 204357, 204358, 204366 and 204367 |
| 204361 | 10473 | Guide Finger Clamp Bar Carrier Latch |
| 200802e | 11291 | Guide Finger Clamp Bar Carrier Latch Hinge Screw |
| 204230 | 11291 | Guide Finger Clamp Bar Carrier Latch Spring |
| 204233 | 10473 | Guide Finger Clamp Bar Carrier Latch Spring 204230 with 200802e |
| 204364 | 10473 | Guide Finger Clamp Bar Carrier Position Guide with 200078u and 200387c |
| 200078u | 10473 | Guide Finger Clamp Bar Carrier Position Guide Pinch Screw |
| 200387c | 10473 | Guide Finger Clamp Bar Carrier Position Guide Screw |

| No. | Plate | Name |
|---------|-------|---|
| 204363 | 10473 | Guide Finger Clamp Bar Carrier Position Guide Slide |
| 200577u | 10473 | Guide Finger Clamp Bar Carrier Position Guide Slide Screw |
| 200785d | 14104 | Guide Finger Clamp Bar Carrier Screw (handle) |
| 200875 | 10473 | Guide Finger Clamp Bar Carrier Screw 200785d with 201537u |
| 201537u | 12319 | Guide Finger Clamp Bar Carrier Screw (handle) Nut |
| 204365 | 10473 | Guide Finger Clamp Bar Carrier Spring |
| 204366 | 10473 | Guide Finger Clamp Bar Position Guide with 200140u |
| 200140u | 11290 | Guide Finger Clamp Bar Position Guide Screw |
| 204367 | 10473 | Guide Finger Clamp Bar Spring ... |
| 200103d | 10473 | " " " " Pinch Screw |
| 200136f | 14104 | Guide Finger Clamp Screw |
| 204368 | 10473 | " " Suspending Stop (adjustable) |
| 200118f | 11290 | Guide Finger Suspending Stop Screw |
| 202603 | 11290 | Guide Finger Suspending Stop Screw Washer |
| *203463 | — | Hook (sewing) |
| 203464 | 11241 | " 203463 with 201253f, 201376f and 203251 |
| 203465 | 11241 | Hook and Bobbin Case complete, Nos. 203217 and 203464 |
| 203241 | 11007 | Hook Bevel Gear Socket, 24 teeth |
| 200555u | 11007 | " " " " Screw ... |
| 203242 | 11007 | " " Pinion, 24 teeth, with two 200383c |
| 200383c | 12311 | Hook Bevel Pinion Set Screw |
| 203243 | 11281 | " Counter Shaft |
| 203244 | 11007 | " " " Collar with two 200393c |
| 200393c | 11007 | Hook Counter Shaft Collar Set Screw |
| 203245 | 11007 | Hook Counter Shaft Driving Gear, 44 teeth, with 200362c and 200139c |
| 213155 | — | Hook Counter Shaft Driving Gear 203245 with 200045e and 213627... |
| 200439c | 12311 | Hook Counter Shaft Driving Gear Position Screw |
| 200362c | 12311 | Hook Counter Shaft Driving Gear Set Screw |

| No. | Plate | Name |
|---------|-------|---|
| 203246 | 11007 | Hook Counter Shaft Gear, 22 teeth, with two 200383c |
| 200383c | 12311 | Hook Counter Shaft Gear Set Screw |
| 202299 | — | " " " Oil Packing (wick) |
| 200840f | 11007 | Hook Counter Shaft Oil Packing (wick) Stop Screw |
| 203247 | 11281 | Hook Driving Shaft |
| 203248 | 11288 | " " " Bearing with 202299 |
| 202299 | — | Hook Driving Shaft Bearing Oil Packing (wick) |
| 202126 | 11285 | Hook Driving Shaft Bearing Position Pin |
| 200516f | 12311 | Hook Driving Shaft Bearing Screw |
| 203249 | 11007 | " " " Bushing (eccentric) |
| 202299 | — | Hook Driving Shaft Bushing Oil Packing (wick) |
| 200362c | 12311 | Hook Driving Shaft Bushing Set Screw |
| 213141 | 14107 | Hook Driving Shaft Collar with two 200393c |
| 200393c | 11007 | Hook Driving Shaft Collar Set Screw |
| 203251 | 11284 | Hook Gib |
| 201376f | 14104 | " " Hinge Screw |
| 201253f | 14104 | " " Screw |
| 203252 | 11288 | " Saddle with 202299 |
| 202299 | — | " " Oil Packing (wick) ... |
| 200019f | 11285 | " " Screw (2) |
| 202622 | 11285 | " " " Washer (2) |
| 203718 | 11241 | " Washer |
| 203466 | 11288 | Hook Saddle complete, Nos. 200555u, 203241, 203252, 203465 and 203718 |
| 228184 | 14108 | Knee Lifter Connection Lever with 202446 |
| 200224u | 11285 | Knee Lifter Connection Lever Hinge Screw |
| 213879 | 14108 | Knee Lifter Connection Lever Lifting Rod with 202302 |
| 202302 | 14104 | Knee Lifter Connection Lever Lifting Rod Cotter Pin |
| 202446 | 14101 | Knee Lifter Connection Lever Pin |
| 228181 | 14102 | " " Lifting Lever |
| 228183 | — | " " " " 228181 with 201178u, 201527u and 228182 ... |
| 228182 | 14102 | Knee Lifter Lifting Lever Bracket |
| 200570f | 12311 | " " " " " Screw |

| No. | Plate | Name |
|---------|-------|--|
| 201178R | 14103 | Knee Lifter Lifting Lever Hinge Screw |
| 201527U | 14103 | Knee Lifter Lifting Lever Hinge Screw Nut |
| 207807 | 10620 | Knife |
| 204369 | 11291 | " Bar (hollow) |
| 213774 | — | " " 204369 with 200094F, 202603 and 204342 |
| 204372 | 11291 | Knife Bar Collar with two 200387C |
| 200387C | 10473 | " " " " Set Screw |
| 213780 | 11289 | " " Driving Bar with two 200585U |
| 200585U | 11285 | Knife Bar Driving Bar Screw |
| 213178 | 11291 | " " " Collar with 200381C and 200387C |
| 213772 | — | Knife Bar Driving Collar 213178 with 200097C, 200243E, 200252C, 213179, 213181, 213628 and two 201528E |
| 200381C | 11291 | Knife Bar Driving Collar Screw .. |
| 200387C | 10473 | " " " " Set Screw |
| 213635 | 11052 | " " " Eccentric with 200382C and 200437C |
| 202890 | 11290 | Knife Bar Driving Eccentric Fork with 200382C and 201464C |
| 201464C | 14103 | Knife Bar Driving Eccentric Fork Position Screw |
| 200382C | 11285 | Knife Bar Driving Eccentric Fork Set Screw |
| 200437C | 12311 | Knife Bar Driving Eccentric Position Screw |
| 200382C | 11285 | Knife Bar Driving Eccentric Set Screw |
| 213181 | 11291 | Knife Bar Driving Link |
| 213179 | 11291 | " " " " Bracket .. |
| 200243E | 11285 | " " " " Hinge Screw |
| 201528E | 11285 | Knife Bar Driving Link Bracket Hinge Screw Nut |
| 200252C | 11291 | Knife Bar Driving Link Hinge Screw |
| 201528E | 11285 | Knife Bar Driving Link Hinge Screw Nut |
| 202891 | 11289 | Knife Bar Driving Shaft Crank with 200694F and 201525E |
| 200694F | 11290 | Knife Bar Driving Shaft Crank Screw Stud |
| 201525E | 11290 | Knife Bar Driving Shaft Crank Screw Stud Nut |

| No. | Plate | Name |
|---------|-------|--|
| 213628 | 11291 | Knife Bar Handle |
| 200097C | 11291 | " " " Screw |
| 204373 | 11291 | " " Position Guide with 200890 |
| 200026D | 11291 | Knife Bar Position Guide Pinch Screw |
| 200890 | 11291 | Knife Bar Position Guide Pinch Screw 200026D with 201534U |
| 201534U | 11293 | Knife Bar Position Guide Pinch Screw Nut |
| 200028B | 11290 | Knife Bar Position Guide Screw .. |
| 204411 | 11290 | " " Sleeve (split) |
| 200043C | 12311 | " " " Set Screw |
| 200888 | 11291 | " " " " " 200043C with 201524E |
| 201524E | 11291 | Knife Bar Sleeve Set Screw Nut.. |
| 214053 | 11291 | " " Throw-out Spring |
| 200047D | 14104 | " " " " Screw (lower) |
| 200301E | 11291 | Knife Bar Throw-out Spring Screw (upper) |
| 204381 | — | Knife Holder |
| 204342 | 11291 | " " 204381 with two 200126F |
| 200094F | 11291 | " " Screw |
| 202603 | 11290 | " " Washer |
| 200126F | 11290 | " Screw |
| 202898 | 11289 | " Switch-out Handle with two 200103C |
| 200403C | 14103 | Knife Switch-out Handle Set Screw |
| 202899 | 11290 | " " " Shaft |
| 202900 | 11290 | " " " Spring (spiral) |
| 204383 | 11289 | Needle Bar (hollow) with 200125F, 200175D and 204250 |
| 207072 | 14104 | Needle Bar Bushing (2) |
| 200398C | 14104 | " " " Set Screw (2) .. |
| 204248 | 11292 | " " Connecting Link |
| 200658C | 11292 | " " " " Hinge Screw Stud |
| 201519E | 14107 | Needle Bar Connecting Link Hinge Screw Stud Nut |
| 204249 | 11292 | Needle Bar Connecting Stud with 200072C and 202277 |
| 202277 | — | Needle Bar Connecting Stud Oil Packing (wick) |
| 200072C | 11292 | Needle Bar Connecting Stud Pinch Screw |
| 204250 | 11292 | Needle Bar Thread Guide |
| 200175D | 11284 | " " " " Screw .. |
| 200125F | 11292 | " Set Screw |

| No. | Plate | Name |
|---------|-------|--|
| 207072 | 14104 | Presser Bar Bushing |
| 200398c | 14104 | " " " Set Screw |
| 202339 | 14104 | " " Lifter |
| 200653c | 14104 | " " " Hinge Screw |
| 204455 | 11287 | " " Lifting Bracket with 200387c |
| 213667 | 14104 | Presser Bar Lifting Bracket Posi- tion Guide with 200075d and 203551 |
| 200075d | 11292 | Presser Bar Lifting Bracket Posi- tion Guide Screw |
| 203551 | 11292 | Presser Bar Lifting Bracket Posi- tion Guide Screw Bushing |
| 200362c | 12311 | Presser Bar Lifting Bracket Posi- tion Guide Set Screw |
| 200387c | 10473 | Presser Bar Lifting Bracket Set Screw |
| 204258 | 11292 | Presser Bar Spring (heavy) |
| 200494b | 14104 | " " Thumb Screw (pres- sure regulating) |
| 201907 | 11293 | Roller Presser, 1½ in. diam., ¾ in. in. face (fine), with 200548c and 201534u |
| 202839 | 11293 | Roller Presser Arm |
| 204569 | 11293 | " " " 202839 with 201907 |
| 202560 | 11293 | Roller Presser Arm Bracket (swing) |
| 204436 | — | " " " " 202560 with 200096d and 204569 |
| 200675f | 11293 | Roller Presser Arm Bracket Posi- tion Screw Stud |
| 202558 | 11293 | Roller Presser Arm Bracket Spring |
| 202559 | 11293 | " " " " " " Stop |
| 200141f | 11293 | Roller Presser Arm Bracket Spring Stop Screw |
| 200096d | 11293 | Roller Presser Arm Screw |
| 204495 | 11289 | " " Bar |
| 200548c | 11293 | " " Hinge Screw |
| 201534u | 11293 | " " " " Nut |
| 204437 | — | Roller Presser and Bar complete, Nos. 200675f, 202558, 202559, 204436, 204495 and two 200141f .. |
| 213006 | 11288 | Take-up Cam with 200335c, 200383c, 200430c, 200658c and 201519c .. |
| 203172 | 11292 | Take-up Cam Friction Washer |
| 200430c | 12311 | " " Position Screw |
| 200383c | 12311 | " " " " Check Screw |

| No. | Plate | Name |
|---------|-------|--|
| 200335c | 12311 | Take-up Cam Set Screw |
| 203270 | 11292 | " Lever |
| 203291 | — | " " 203270 with 204263 ... |
| 204263 | 11292 | " " Bearing with 204264 .. |
| 204264 | 11292 | " " " Position Pin ... |
| 200042f | 12311 | " " " Screw |
| 201816 | 11292 | " " Roller |
| 203271 | 11292 | Take-up Lever complete, Nos. 200042f, 201816 and 203291 |
| 244007 | 12349 | Tension Disc |
| 202090 | 12349 | " " Position Pin |
| 223423 | 14107 | " Release Lever |
| 200309i | 12349 | " " " Screw |
| 202075 | 12349 | " " Plunger |
| 223427 | 14107 | " " Slide |
| 204457 | 14104 | " " " Spring |
| 202737 | 14104 | " " " " Adjusting Collar with 200380c |
| 200380c | 14107 | Tension Release Slide Spring Ad- justing Collar Set Screw |
| 202407 | 10881 | Tension Spring |
| 200632b | 12349 | " Stud |
| 200397h | 12349 | " " Set Screw |
| 201572b | 10881 | " Thumb Nut |
| 204271 | 12349 | " Washer |
| 204272 | 12349 | Tension complete, Nos. 200632b, 201572b, 202075, 202407, 204271 and two 244007 |
| 204274 | 12349 | Thread Controller Plate |
| 200577h | 10473 | " " " Screw |
| 202098 | 12349 | " " Roller |
| 204275 | 12349 | " " " Guard |
| 202084 | 12349 | " " " " Washer |
| 200300c | 12349 | " " " Screw |
| 204276 | 12349 | " " Spring |
| 204333 | 12349 | " " " Guard |
| 200581h | 12349 | " " " " Screw .. |
| 202087 | 12349 | " " " Stop |
| 202088 | 12349 | " " " Stud with 204925 |
| 200366h | 12349 | Thread Controller Spring Stud Set Screw |
| 204925 | 11292 | Thread Controller Spring Stud Washer |
| 205987 | 12349 | Thread Controller complete, Nos. 200300c, 200581h, 202084, 202098, 204274, 204275 and 204333 |
| 204280 | 12349 | Thread Controller and Spring com- plete, Nos. 204276 and 205987 .. |

| No. | Plate | Name |
|---------|-------|---|
| 202412 | 11292 | Thread Guide |
| 202413 | 11292 | " " |
| 202091 | 12349 | " Retainer Sleeve |
| 202092 | 12349 | " " Spring |
| 204058 | 12349 | " " Stud |
| 200368H | 12349 | " " " Set Screw |
| 204059 | 12349 | Thread Retainer complete, Nos. 202091, 202092 and 204058 |
| 213163 | 14102 | Throat Plate Adjusting Lever with 200627E, 201539E, 204387 and two 200479F |
| 200264D | 11052 | Throat Plate Adjusting Lever Hinge Screw |
| 200479E | 11052 | Throat Plate Adjusting Lever Position Screw |
| 200627E | 11052 | Throat Plate Adjusting Lever Screw Stud |
| 201539E | 11052 | Throat Plate Adjusting Lever Screw Stud Nut |
| 201556D | 14103 | Throat Plate Adjusting Lever Screw Stud Thumb Nut |
| 213112 | 14101 | Throat Plate Adjusting Lever Screw Stud Thumb Nut Washer Plate |
| 203152 | 14103 | Throat Plate Adjusting Lever Screw Stud Thumb Nut Washer Plate Pin (2) |
| 223444 | 14106 | Throat Plate Body |
| 207470 | 12060 | " " Knife Cutting Bar, 53 needle hole, for needle sizes 12 and 13, trims opposite the needle and .040 in. to right of seam |
| 200583H | 14107 | Throat Plate Knife Cutting Bar Screw |
| 200585H | 11285 | Throat Plate Screw (2) |
| 213162 | 14102 | " " Slide Plate (adjustable) |
| 204387 | 14101 | Throat Plate Slide Plate Position Stud |
| 200306D | 11052 | Throat Plate Slide Plate Screw (2) |
| 211499 | 12061 | Throat Plate complete, 53 needle hole, for needle sizes 12 and 13, trims opposite the needle and .040 in. to right of seam, Nos. 207470, 223444 and two 200583H |

LIST OF PARTS COMPLETE

FOR

MACHINE No. 29w17

DROP FEED. OBLIQUE UNDEREDGE TRIMMER

For Leather

| No. | Plate | Name |
|---------|-------|--|
| *213166 | - | Arm |
| 213921 | 11282 | " Cap |
| 200278H | 12311 | " " Screw |
| 202248 | 11285 | " " " Washer |
| 203089 | 11282 | " " Spool Holder Base |
| 203090 | 11282 | " " " " " " 203089 with 200079H and 204296 |
| 200585H | 11285 | Arm Cap Spool Holder Base Screw |
| 204296 | 11282 | " " " " Wire |
| 200079H | 12311 | " " " " " " Hinge Screw |
| 213922 | - | Arm Cap and Spool Holder complete, Nos. 203090, 213921 and two 200585H |
| 200010E | - | Arm Screw (3) |
| 202005 | 11285 | " " Washer (3) |
| 213158 | 11281 | " Shaft |
| 223431 | - | " " 213158 with 200244D, 200245D, 213150, 213354, 213654, 213655, 223429, 223430 and two 201528E |
| 204891 | 11282 | Arm Shaft Bushing (back) with 202260 |
| 202260 | - | Arm Shaft Bushing (back) Oil Packing (wick) |
| 200338c | 11048 | Arm Shaft Bushing (back) Set Screw |
| 213299 | 11282 | Arm Shaft Bushing (center) with 202260 |
| 202260 | - | Arm Shaft Bushing (center) Oil Packing (wick) |
| 200338c | 11048 | Arm Shaft Bushing (center) Set Screw |
| 204802 | 11282 | Arm Shaft Bushing (front) with 202036 and 202260 |
| 202260 | - | Arm Shaft Bushing (front) Oil Packing (wick) |

From the library of: Diamond Needle Corp

| No. | Plate | Name |
|---------|-------|--|
| 200502b | 11285 | Arm Shaft Bushing (front) Oil Packing Thumb Screw |
| 202036 | 11285 | Arm Shaft Bushing (front) Position Pin |
| 200341c | 11285 | Arm Shaft Bushing (front) Set Screw |
| 204804 | 11281 | Arm Shaft Connection with four 200054e (2) |
| 200054e | 11285 | Arm Shaft Connection Screw |
| 213153 | 11281 | Balance Wheel, 5½ in. diam. (belt groove 2¾ in. diam.) with 200328c and 200335c |
| 200062h | 12311 | Balance Wheel Adjusting Screw .. |
| 200328c | 12311 | " " Position Screw ... |
| 200335c | 12311 | " " Set Screw |
| *213652 | ---- | Bed with 203248, 203249, two each 200362c, 200516e, 200840e and 202299 |
| 202258 | 12153 | Bed Hinge Connection (2) |
| 200570e | 12311 | " " " Screw (4) |
| 203329 | 11282 | " Slide (back) |
| 203207 | 11282 | " " (front) |
| 203470 | 11284 | Bobbin |
| *203670 | ---- | " Case |
| 203648 | 11284 | " " Latch |
| *202056 | ---- | " " " Pin |
| 203473 | 11284 | " " " Plunger |
| 203474 | 11284 | " " " Spring |
| 203499 | 11287 | " " Lever |
| *203476 | ---- | " " " Eccentric |
| 204243 | 11284 | " " " " Position Pin |
| 203506 | 11287 | " " " Fulcrum |
| 200056E | 10882 | " " " " Screw |
| 203478 | 11284 | " " " Slide Stud |
| 203214 | 11284 | " " Tension Spring |
| 200984c | 11284 | " " " " Regulat- ing Screw |
| 200594c | 11284 | Bobbin Case Tension Spring Screw |
| 203216 | ---- | " " Washer (cloth) |
| 203669 | 11284 | Bobbin Case complete, Nos. 200594c, 200984c, 202056, 203214, 203216, 203473, 203474, 203648 and 203670 |
| 204353 | 11283 | Bracket (underedge) with 204411.. |
| 200517D | 11290 | " Screw (2) |
| 213629 | 11283 | Bracket (underedge) complete, Nos. 200047D, 200118E, 200577H, 200888, 202603, 204233, 204353, 204361, 204363 to 204365, 204368, 204372, 204373, 213772, 213774, 213777, 214053 and two 200028B |

| No. | Plate | Name |
|---------|-------|---|
| 223421 | 14102 | Face Plate with 200366H, 200368H, 202087, 202090, 204185 and two 200397H |
| 200065c | 11285 | Face Plate Screw (2) |
| 204185 | 11292 | " " Thread Guide |
| 200397H | 12349 | " " " " Set Screw |
| 223422 | --- | Face Plate complete, Nos. 200309E, 200577H, 202088, 204059, 204272, 204280, 223421 and 223423 |
| 213146 | 11282 | Feed Bar |
| 213229 | ---- | " " 213146 with 200641c, 201522e and 213147 |
| 200641c | 11048 | Feed Bar Hinge Screw |
| 201522e | 11285 | " " " Nut |
| 207651 | 11106 | " Dog |
| 200106e | 12311 | " " Screw (2) |
| 223429 | 11298 | " Driving Eccentric (adjustable) |
| 223430 | 11298 | " " " Adjusting Disc |
| 213150 | 11282 | " " " Flange with 200378c and 200437c |
| 200437c | 12311 | Feed Driving Eccentric Flange Position Screw |
| 200378c | 12311 | Feed Driving Eccentric Flange Set Screw |
| 213655 | 11048 | Feed Driving Eccentric Friction Spring Washer |
| 200245D | 11048 | Feed Driving Eccentric Friction Spring Washer Screw |
| 201528e | 11285 | Feed Driving Eccentric Friction Spring Washer Screw Nut |
| 200244D | 11048 | Feed Driving Eccentric Fulcrum Screw |
| 201528e | 11285 | Feed Driving Eccentric Fulcrum Screw Nut |
| 213147 | 11281 | Feed Driving Rock Shaft |
| 202305 | 11285 | " " " " Center (2) |
| 200043c | 12311 | " " " " " Set Screw (2) |
| 213354 | 11281 | Feed Driving Rock Shaft Connection with 200054e and 202277 ... |
| 213654 | 11048 | Feed Driving Rock Shaft Connection Collar |
| 202298 | 11048 | Feed Driving Rock Shaft Connection Crank with 200038c |
| 200038c | 11048 | Feed Driving Rock Shaft Connection Crank Pinch Screw |
| 200545c | 11048 | Feed Driving Rock Shaft Connection Hinge Screw |
| 201518e | 11285 | Feed Driving Rock Shaft Connection Hinge Screw Nut |

| No. | Plate | Name |
|---------|-------|--|
| 202277 | — | Feed Driving Rock Shaft Connection Oil Packing (wick) |
| 200054E | 11285 | Feed Driving Rock Shaft Connection Pinch Screw |
| 213627 | 11285 | Feed Lifting Cam with 202126 |
| 204202 | 11285 | " " " Fork with 200027E |
| 200027E | 11285 | " " " Pinch Screw |
| 202126 | 11285 | " " " Position Pin |
| 200045E | 11285 | " " " Screw |
| 203236 | 11281 | " " Rock Shaft |
| 203316 | 11281 | " " " " 203236 with 203238 |
| 202305 | 11285 | Feed Lifting Rock Shaft Center (2) |
| 200043C | 12311 | " " " " " Set Screw (2) |
| 202276 | 11285 | Feed Lifting Rock Shaft Slide Block |
| 203238 | 11285 | " " " " " " " " 202276 with 200243E and 201531E |
| 200243E | 11285 | Feed Lifting Rock Shaft Slide Block Hinge Screw |
| 200531E | 11285 | Feed Lifting Rock Shaft Slide Block Hinge Screw Nut |
| 213161 | 11048 | Feed Regulating Lever with 213657 |
| 200665C | 11048 | " " " Hinge Screw |
| 213656 | 14104 | " " " Spring |
| 213657 | 14104 | " " " " Pin .. |
| 204356 | 11291 | Guide Finger |
| 204357 | 10473 | " " Clamp with 200103D and 200136E |
| 204358 | 10473 | Guide Finger Clamp Bar |
| 204359 | 10473 | " " " " Carrier with 200875 |
| 213777 | — | Guide Finger Clamp Bar Carrier 204359 with 204357, 204358, 204366 and 204367 |
| 204361 | 10473 | Guide Finger Clamp Bar Carrier Latch |
| 200802E | 11291 | Guide Finger Clamp Bar Carrier Latch Hinge Screw |
| 204230 | 11291 | Guide Finger Clamp Bar Carrier Latch Spring |
| 204233 | 10473 | Guide Finger Clamp Bar Carrier Latch Spring 204230 with 200802E |
| 204364 | 10473 | Guide Finger Clamp Bar Carrier Position Guide with 200078U and 200387C |
| 200078U | 10473 | Guide Finger Clamp Bar Carrier Position Guide Pinch Screw |
| 200387C | 10473 | Guide Finger Clamp Bar Carrier Position Guide Screw |

| No. | Plate | Name |
|---------|-------|---|
| 204363 | 10473 | Guide Finger Clamp Bar Carrier Position Guide Slide |
| 200577U | 10473 | Guide Finger Clamp Bar Carrier Position Guide Slide Screw |
| 200785D | 14104 | Guide Finger Clamp Bar Carrier Screw (handle) |
| 200875 | 10473 | Guide Finger Clamp Bar Carrier Screw 200785D with 201537U |
| 201537U | 10473 | Guide Finger Clamp Bar Carrier Screw (handle) Nut |
| 204365 | 10473 | Guide Finger Clamp Bar Carrier Spring |
| 204366 | 10473 | Guide Finger Clamp Bar Position Guide with 200140U |
| 200140U | 11290 | Guide Finger Clamp Bar Position Guide Screw |
| 204367 | 10473 | Guide Finger Clamp Bar Spring .. |
| 200103D | 10473 | " " " Pinch Screw .. |
| 200136E | 14104 | " " " Screw |
| 204368 | 10473 | " " Suspending Stop (adjustable) |
| 200118E | 11290 | Guide Finger Suspending Stop Screw |
| 202603 | 11290 | Guide Finger Suspending Stop Screw Washer |
| *203482 | — | Hook (sewing) |
| 203483 | 11287 | " 203482 with 201253E, 201376E and 203251 |
| 203671 | 11287 | Hook and Bobbin Case complete, Nos. 203483 and 203669 |
| 213810 | 11287 | Hook Bevel Gear Socket, 24 teeth |
| 200555U | 11007 | " " " " Screw ... |
| 203242 | 11007 | " " Pinion, 24 teeth, with two 200383C |
| 200383C | 12311 | Hook Bevel Pinion Set Screw |
| 203243 | 11281 | " Counter Shaft |
| 203244 | 11007 | " " " Collar with two 200393C |
| 200393C | 11007 | Hook Counter Shaft Collar Set Screw |
| 203245 | 11007 | Hook Counter Shaft Driving Gear, 44 teeth, with 200362C and 200439C |
| 213155 | — | Hook Counter Shaft Driving Gear 203245 with 200045E and 213627.. |
| 200439C | 12311 | Hook Counter Shaft Driving Gear Position Screw |
| 200362C | 12311 | Hook Counter Shaft Driving Gear Set Screw |
| 203246 | 11007 | Hook Counter Shaft Gear, 22 teeth, with two 200383C |

| No. | Plate | Name |
|---------|-------|---|
| 200383c | 12311 | Hook Counter Shaft Gear Set Screw |
| 202299 | — | " " " Oil Packing (wick) |
| 200840e | 11007 | Hook Counter Shaft Oil Packing (wick) Stop Screw |
| 203247 | 11281 | Hook Driving Shaft |
| 203248 | 11288 | " " " Bearing with 202299 |
| 202299 | — | Hook Driving Shaft Bearing Oil Packing (wick) |
| 202126 | 11285 | Hook Driving Shaft Bearing Position Pin |
| 200516e | 12311 | Hook Driving Shaft Bearing Screw |
| 203249 | 11007 | " " " Bushing (eccentric) |
| 202299 | — | Hook Driving Shaft Bushing Oil Packing (wick) |
| 200362c | 12311 | Hook Driving Shaft Bushing Set Screw |
| 213141 | 14107 | Hook Driving Shaft Collar with two 200393e |
| 200393c | 11007 | Hook Driving Shaft Collar Set Screw |
| 203251 | 11284 | Hook Gib |
| 201376f | 14104 | " " Hinge Screw |
| 201253f | 14104 | " " Screw |
| 203504 | 11288 | " Saddle with 200056e |
| 200006e | 11007 | " " Screw (2) |
| 225585 | 11007 | " " Washer (2) |
| 213018 | — | " Washer with 203476 and two 204243 |
| 203680 | 11288 | Hook Saddle complete, Nos. 200555u, 203478, 203499, 203504, 203506, 203671, 213018 and 213810 |
| 228184 | 14108 | Knee Lifter Connection Lever with 202246 |
| 200224u | 11285 | Knee Lifter Connection Lever Hinge Screw |
| 213879 | 14108 | Knee Lifter Connection Lever Lifting Rod with 202302 |
| 202302 | 14104 | Knee Lifter Connection Lever Lifting Rod Cotter Pin |
| 202446 | 14101 | Knee Lifter Connection Lever Pin |
| 228181 | 14102 | " " Lifting Lever |
| 228183 | — | " " " " 228181 with 201178u, 201527u and 228182 |
| 228182 | 14102 | Knee Lifter Lifting Lever Bracket |
| 200570e | 12311 | " " " " " Screw |

| No. | Plate | Name |
|---------|-------|--|
| 201178u | 14103 | Knee Lifter Lifting Lever Hinge Screw |
| 201527u | 14103 | Knee Lifter Lifting Lever Hinge Screw Nut |
| 207807 | 10620 | Knife |
| 204369 | 11291 | " Bar (hollow) |
| 213774 | — | " " 204369 with 200094e, 202603 and 204342 |
| 204372 | 11291 | Knife Bar Collar with two 200387c |
| 200387c | 10473 | " " " Set Screw |
| 213780 | 11289 | " " Driving Bar with two 200585u |
| 200585u | 11285 | Knife Bar Driving Bar Screw |
| 213178 | 11291 | " " " Collar with 200381c and 200387c |
| 213772 | — | Knife Bar Driving Collar 213178 with 200097c, 200243e, 200252c, 213179, 213181, 213628 and two 201528e |
| 200381c | 11291 | Knife Bar Driving Collar Screw .. |
| 200387c | 10473 | " " " " Set Screw |
| 213635 | 11052 | " " " Eccentric with 200382c and 200437c |
| 202890 | 11290 | Knife Bar Driving Eccentric Fork with 200382c and 201464c |
| 201464c | 14103 | Knife Bar Driving Eccentric Fork Position Screw |
| 200382c | 11285 | Knife Bar Driving Eccentric Fork Set Screw |
| 200437c | 12311 | Knife Bar Driving Eccentric Position Screw |
| 200382c | 11285 | Knife Bar Driving Eccentric Set Screw |
| 213181 | 11291 | Knife Bar Driving Link |
| 213179 | 11291 | " " " " Bracket |
| 200243e | 11285 | " " " " " " Hinge Screw |
| 201528e | 11285 | Knife Bar Driving Link Bracket Hinge Screw Nut |
| 200252c | 11291 | Knife Bar Driving Link Hinge Screw |
| 201528e | 11285 | Knife Bar Driving Link Hinge Screw Nut |
| 202891 | 11289 | Knife Bar Driving Shaft Crank with 200694e and 201525e |
| 200694e | 11290 | Knife Bar Driving Shaft Crank Screw Stud |
| 201525e | 11290 | Knife Bar Driving Shaft Crank Screw Stud Nut |

| No. | Plate | Name |
|---------|-------|---|
| 213628 | 11291 | Knife Bar Handle |
| 200097c | 11291 | " " " Screw |
| 204373 | 11291 | " " Position Guide with 200890 |
| 200026b | 11291 | Knife Bar Position Guide Pinch Screw |
| 200890 | 11291 | Knife Bar Position Guide Pinch Screw 200026b with 201534u |
| 201534u | 11293 | Knife Bar Position Guide Pinch Screw Nut |
| 200028b | 11290 | Knife Bar Position Guide Screw .. |
| 204411 | 11290 | " " Sleeve (split) |
| 200043c | 12311 | " " " Set Screw |
| 200888 | 11291 | " " " " " 200043c with 201524e |
| 201524e | 11291 | Knife Bar Sleeve Set Screw Nut.. |
| 214053 | 11291 | " " Throw-out Spring |
| 200047b | 14104 | " " " " Screw (lower) |
| 200301e | 11291 | Knife Bar Throw-out Spring Screw (upper) |
| 204381 | --- | Knife Holder |
| 204342 | 11291 | " " 204381 with two 200126f |
| 200094f | 11291 | " " Screw |
| 202603 | 11290 | " " Washer |
| 200126f | 11290 | " Screw |
| 202898 | 11289 | " Switch-out Handle with two 200403c |
| 200403c | 14103 | Knife Switch-out Handle Set Screw |
| 202899 | 11290 | " " " Shaft |
| 202900 | 11290 | " " " Spring (spiral) |
| 204383 | 11289 | Needle Bar (hollow) with 200125f, 200175b and 204250 |
| 207072 | 14104 | Needle Bar Bushing (2) |
| 200398c | 14104 | " " " Set Screw (2) .. |
| 204248 | 11292 | " " Connecting Link |
| 200658c | 11292 | " " " " Hinge Screw Stud |
| 201519e | 11292 | Needle Bar Connecting Link Hinge Screw Stud Nut |
| 204249 | 11292 | Needle Bar Connecting Stud with 200072c and 202277 |
| 202277 | --- | Needle Bar Connecting Stud Oil Packing (wick) |
| 200072c | 11292 | Needle Bar Connecting Stud Pinch Screw |
| 204250 | 11292 | Needle Bar Thread Guide |
| 200175b | 11284 | " " " " Screw .. |
| 200125f | 11292 | " Set Screw |

| No. | Plate | Name |
|---------|-------|--|
| 207072 | 14104 | Presser Bar Bushing |
| 200398c | 14104 | " " " Set Screw ... |
| 202339 | 14104 | " " Lifter |
| 200653c | 14104 | " " " Hinge Screw ... |
| 204455 | 11287 | " " Lifting Bracket with 200387c |
| 213667 | 14104 | Presser Bar Lifting Bracket Posi- tion Guide with 200075b and 203551 |
| 200075b | 11292 | Presser Bar Lifting Bracket Posi- tion Guide Screw |
| 203551 | 11292 | Presser Bar Lifting Bracket Posi- tion Guide Screw Bushing |
| 200362c | 12311 | Presser Bar Lifting Bracket Posi- tion Guide Set Screw |
| 200387c | 10473 | Presser Bar Lifting Bracket Set Screw |
| 204258 | 11292 | Presser Bar Spring (heavy) |
| 200494b | 14104 | " " Thumb Screw (pres- sure regulating) |
| 201907 | 11293 | Roller Presser, 1 1/2 in. diam., 3/8 in. face (fine), with 200548c and 201534u |
| 202839 | 11293 | Roller Presser Arm |
| 204569 | 11293 | " " " 202839 with 201907 |
| 202560 | 11293 | Roller Presser Arm Bracket (swing) |
| 204436 | --- | " " " " 202560 with 200096b and 204569 |
| 200675f | 11293 | Roller Presser Arm Bracket Posi- tion Screw Stud |
| 202558 | 11293 | Roller Presser Arm Bracket Spring |
| 202559 | 11293 | " " " " " " Stop |
| 200141f | 11293 | Roller Presser Arm Bracket Spring Stop Screw |
| 200096b | 11293 | Roller Presser Arm Screw |
| 204495 | 11289 | " " Bar |
| 200548c | 11293 | " " Hinge Screw |
| 201534u | 11293 | " " " " Nut |
| 204437 | --- | Roller Presser and Bar complete, Nos. 200675f, 202558, 202559, 204436, 204495 and two 200141f .. |
| 213006 | 11288 | Take-up Cam with 200335c, 200383c, 200430c, 200658c and 201519e ... |
| 203172 | 11292 | Take-up Cam Friction Washer ... |
| 200430c | 12311 | " " Position Screw |
| 200383c | 12311 | " " " " Check Screw |

| No. | Plate | Name |
|---------|-------|--|
| 200335c | 12311 | Take-up Cam Set Screw |
| 203270 | 11292 | " Lever |
| 203291 | — | " " 203270 with 204263 .. |
| 204263 | 11292 | " " Bearing with 204264 .. |
| 204264 | 11292 | " " Position Pin ... |
| 200042F | 12311 | " " " Screw |
| 201816 | 11292 | " " Roller |
| 203271 | 11292 | Take-up Lever complete, Nos 200042F, 201816 and 203291 |
| 244007 | 12349 | Tension Disc |
| 202090 | 12349 | " " Position Pin |
| 223423 | 14107 | " Release Lever |
| 200309E | 12349 | " " " Screw |
| 202075 | 12349 | " " Plunger |
| 223427 | 14107 | " " Slide |
| 204457 | 14104 | " " " Spring |
| 202737 | 14104 | " " " " Adjusting Collar with 200380c |
| 200380c | 14107 | Tension Release Slide Spring Ad- justing Collar Set Screw |
| 202407 | 10881 | Tension Spring |
| 200632B | 12349 | " Stud |
| 200397H | 12349 | " " Set Screw |
| 201572B | 10881 | " Thumb Nut |
| 204271 | 12349 | " Washer |
| 204272 | 12349 | Tension complete, Nos. 200632B, 201572B, 202075, 202407, 204271 and two 244007 |
| 204274 | 12349 | Thread Controller Plate |
| 200577H | 10473 | " " " Screw |
| 202098 | 12349 | " " Roller |
| 204275 | 12349 | " " " Guard |
| 202084 | 12349 | " " " " Washer |
| 200300H | 12349 | " " " Screw |
| 204276 | 12349 | " " Spring |
| 204333 | 12349 | " " " Guard |
| 200581H | 12349 | " " " " Screw.. |
| 202087 | 12349 | " " " Stop |
| 202088 | 12349 | " " " Stud with 204925 |
| 200366H | 12349 | Thread Controller Spring Stud Set Screw |
| 204925 | 11292 | Thread Controller Spring Stud Washer |
| 205987 | 12349 | Thread Controller complete, Nos. 200300c, 200581H, 202084, 202098, 204274, 204275 and 204333 |
| 204280 | 12349 | Thread Controller and Spring com- plete, Nos. 204276 and 205987 ... |

| No. | Plate | Name |
|---------|-------|---|
| 202412 | 11292 | Thread Guide |
| 202413 | 11292 | " " |
| 202091 | 12349 | " Retainer Sleeve |
| 202092 | 12349 | " " Spring |
| 204058 | 12349 | " " Stud |
| 200368H | 12349 | " " " Set Screw |
| 204059 | 12349 | Thread Retainer complete, Nos. 202091, 202092 and 204058 |
| 213163 | 14102 | Throat Plate Adjusting Lever with 200627E, 201539E, 204387 and two 200479F |
| 200264D | 11052 | Throat Plate Adjusting Lever Hinge Screw |
| 200479F | 11052 | Throat Plate Adjusting Lever Posi- tion Screw |
| 200627E | 11052 | Throat Plate Adjusting Lever Screw Stud |
| 201539E | 11052 | Throat Plate Adjusting Lever Screw Stud Nut |
| 201556D | 14103 | Throat Plate Adjusting Lever Screw Stud Thumb Nut |
| 213112 | 14101 | Throat Plate Adjusting Lever Screw Stud Thumb Nut Washer Plate |
| 203152 | 14103 | Throat Plate Adjusting Lever Screw Stud Thumb Nut Washer Plate Pin (2) |
| 223446 | 14106 | Throat Plate Body |
| 207470 | 12060 | " " Knife Cutting Bar, 53 needle hole, for needle sizes 12 and 13, trims opposite the needle and .040 in. to right of seam .. |
| 200583H | 14107 | Throat Plate Knife Cutting Bar Screw |
| 200585H | 11285 | Throat Plate Screw (2) |
| 213162 | 14102 | " " Slide Plate (adjustable) |
| 204387 | 14101 | " " " " Position Stud |
| 200306D | 11052 | " " " " Screw (2) .. |
| 211521 | 12065 | Throat Plate complete, 53 needle hole, for needle sizes 12 and 13, trims opposite the needle and .040 in. to right of seam, Nos. 207470, 223446 and two 200583H |

LIST OF PARTS COMPLETE

FOR

MACHINE No. 29w21

WHEEL FEED. OBLIQUE UNDEREDGE TRIMMER

For Leather and Gloves

| No. | Plate | Name |
|---------|-------|---|
| *213166 | — | Arm |
| 213921 | 11282 | " Cap |
| 200278H | 12311 | " " Screw |
| 202248 | 11285 | " " " Washer |
| 203089 | 11282 | " " Spool Holder Base |
| 203090 | 11282 | " " " " " 203089 with 200079H and 204296 |
| 200585H | 11285 | Arm Cap Spool Holder Base Screw |
| 204296 | 11282 | " " " " Wire |
| 200079H | 12311 | " " " " " Hinge Screw |
| 213922 | — | Arm Cap and Spool Holder complete, Nos. 203090, 213921 and two 200585H |
| 200010E | — | Arm Screw (3) |
| 202005 | 11285 | " " Washer (3) |
| 213158 | 11281 | " Shaft |
| 223431 | — | " " 213158 with 200244D, 200245D, 213150, 213354, 213654, 213655, 223429, 223430 and two 201528E |
| 204801 | 11282 | Arm Shaft Bushing (back) with 202260 |
| 202260 | — | Arm Shaft Bushing (back) Oil Packing (wick) |
| 200338c | 11048 | Arm Shaft Bushing (back) Set Screw |
| 213299 | 11282 | Arm Shaft Bushing (center) with 202260 |
| 202260 | — | Arm Shaft Bushing (center) Oil Packing (wick) |
| 200338c | 11048 | Arm Shaft Bushing (center) Set Screw |
| 204802 | 11282 | Arm Shaft Bushing (front) with 202036 and 202260 |

| No. | Plate | Name |
|---------|-------|---|
| 202260 | — | Arm Shaft Bushing (front) Oil Packing (wick) |
| 200502B | 11285 | Arm Shaft Bushing (front) Oil Packing Thumb Screw |
| 202036 | 11285 | Arm Shaft Bushing (front) Position Pin |
| 200341c | 11285 | Arm Shaft Bushing (front) Set Screw |
| 204804 | 11281 | Arm Shaft Connection with four 200054E (2) |
| 200054E | 11285 | Arm Shaft Connection Screw |
| 213153 | 11281 | Balance Wheel, 5½ in. diam. (belt groove 2¾ in. diam.), with 200328c and 200335c |
| 200062H | 12311 | Balance Wheel Adjusting Screw .. |
| 200328c | 12311 | " " Position Screw |
| 200335c | 12311 | " " Set Screw |
| *213868 | — | Bed with 203248, 203249, two each 200362c, 200516E, 200840E and 202299 |
| 202258 | 12153 | Bed Hinge Connection (2) |
| 200570E | 12311 | " " " Screw (4) |
| 203329 | 11282 | " Slide (back) |
| 203207 | 11282 | " " (front) |
| 203208 | 11284 | Bobbin |
| 203210 | 11284 | " Case Base with 202056, 203211 to 203213 and 203216 |
| 203211 | 11284 | Bobbin Case Base Latch |
| *202056 | — | " " " " Pin |
| 203212 | 11284 | " " " " Plunger .. |
| 203213 | 11284 | " " " " Spring .. |
| 203209 | 11284 | " " Cap with 200984c, 203214, 203215 and two 200594c.. |
| 203214 | 11284 | Bobbin Case Tension Spring |
| 200984c | 11284 | " " " " Regulat- ing Screw |
| 200594c | 11284 | Bobbin Case Tension Spring Screw |
| 203216 | — | " " Washer (cloth) |
| 203217 | 11284 | Bobbin Case complete, Nos. 203209 and 203210 |
| 204353 | 11283 | Bracket (underedge) with 204411 .. |
| 200517D | 11290 | " Screw (2) |
| 213629 | 11283 | Bracket (underedge) complete, Nos. 200047D, 200118E, 200577H, 200888, 202603, 204233, 204353, 204361, 204363 to 204365, 204368, 204372, 204373, 213772, 213774, 213777, 214073 and two 200028H |

| No. | Plate | Name |
|---------|-------|---|
| 223421 | 14102 | Face Plate with 200366n, 200368n, 202087, 202090, 204185 and two 200397n |
| 200065c | 11285 | Face Plate Screw (2) |
| 204185 | 11292 | " " Thread Guide |
| 200397n | 12349 | " " " " Set Screw |
| 223422 | — | Face Plate complete, Nos. 200309f, 200577n, 202088, 204059, 204272, 204280, 223421 and 223423 |
| 223429 | 11298 | Feed Driving Eccentric (adjustable) |
| 223430 | 11298 | " " " " Adjusting Disc |
| 213150 | 11282 | " " " " Flange with 200378c and 200437c |
| 200437c | 12311 | Feed Driving Eccentric Flange Position Screw |
| 200378c | 12311 | Feed Driving Eccentric Flange Set Screw |
| 213655 | 11048 | Feed Driving Eccentric Friction Spring Washer |
| 200245d | 11048 | Feed Driving Eccentric Friction Spring Washer Screw |
| 201528e | 11285 | Feed Driving Eccentric Friction Spring Washer Screw Nut |
| 200244d | 11048 | Feed Driving Eccentric Fulerum Screw |
| 201528e | 11285 | Feed Driving Eccentric Fulerum Screw Nut |
| 213863 | 11281 | Feed Driving Rock Shaft |
| 202305 | 11285 | " " " " Center (2) |
| 200043c | 12311 | " " " " " Set Screw (2) |
| 213354 | 11281 | Feed Driving Rock Shaft Connection with 200054e and 202277 |
| 213654 | 11048 | Feed Driving Rock Shaft Connection Collar |
| 202298 | 11048 | Feed Driving Rock Shaft Connection Crank with 200038c |
| 200038c | 11048 | Feed Driving Rock Shaft Connection Crank Pinch Screw |
| 200545c | 11048 | Feed Driving Rock Shaft Connection Hinge Screw |
| 201518e | 11285 | Feed Driving Rock Shaft Connection Hinge Screw Nut |
| 202277 | — | Feed Driving Rock Shaft Connection Oil Packing (wick) |
| 200054e | 11285 | Feed Driving Rock Shaft Connection Pinch Screw |

| No. | Plate | Name |
|---------|-------|--|
| 213161 | 11048 | Feed Regulating Lever with 213657 |
| 200665c | 11048 | " " " " Hinge Screw |
| 213656 | 14104 | " " " " Spring |
| 213657 | 14104 | " " " " Pin |
| 204303 | 11288 | " Wheel |
| 223010 | 14103 | " " Driver with two each each 201209f and 201515e |
| 201209f | 14103 | Feed Wheel Driver Clutch Stud |
| 201515e | 14103 | " " " " " Nut |
| 223011 | — | Feed Wheel Driver and Clutch complete, Nos. 200263f, 200266d, 201528e, 204308, 204310 and 223010 |
| 204308 | 14104 | Feed Wheel Driver Crank with two 200383c |
| 200266d | 11286 | Feed Wheel Driver Crank Hinge Screw |
| 200383c | 12311 | Feed Wheel Driver Crank Set Screw |
| 204335 | 11286 | Feed Wheel Driver Guide |
| 200162d | 11286 | " " " " " Screw |
| 204310 | 11286 | " " " " Link |
| 200263f | 11286 | " " " " " Hinge Screw |
| 201528e | 11285 | " " " " " " Nut |
| 223043 | — | Feed Wheel Driver Spring (spiral) |
| 204190 | 11292 | " " " " " Hook (upper) |
| 204336 | 14512 | Feed Wheel Frame with 200383c, 204190 and 204321 |
| 204315 | 11286 | Feed Wheel Frame Adjusting Eccentric |
| 200347c | 14103 | Feed Wheel Frame Adjusting Eccentric Set Screw |
| 200383c | 12311 | Feed Wheel Frame Set Screw |
| 204337 | 11281 | " " " " Shaft |
| 202305 | 11285 | " " " " " Center (2) |
| 200043c | 12311 | " " " " " " Set Screw (2) |
| 204317 | 11286 | Feed Wheel Friction Spring |
| 200162d | 11286 | " " " " " " Screw |
| 204425 | — | Feed Wheel Frame complete, Nos. 204303, 204317, 204320, 204335, 204336, 206047 and four 200162d |
| 206047 | 11286 | Feed Wheel Retaining Clutch with 204189 |
| 204320 | 11286 | Feed Wheel Retaining Clutch Spring |
| 204189 | 11292 | Feed Wheel Retaining Clutch Spring Hook |

| No. | Plate | Name |
|---------|-------|--|
| 204321 | 11286 | Feed Wheel Retaining Clutch Spring Pin |
| 200162D | 11286 | Feed Wheel Retaining Screw |
| 204355 | 11291 | Guide Finger, for trimming back of needle |
| 204356 | 11291 | Guide Finger, for trimming abreast of needle |
| 204357 | 10473 | Guide Finger Clamp with 200103D and 200136F |
| 204358 | 10473 | Guide Finger Clamp Bar |
| 204359 | 10473 | " " " " Carrier with 200875 |
| 213777 | — | Guide Finger Clamp Bar Carrier 204359 with 204357, 201358, 204266 and 204367 |
| 204361 | 10473 | Guide Finger Clamp Bar Carrier Latch |
| 200802E | 11291 | Guide Finger Clamp Bar Carrier Latch Hinge Screw |
| 204230 | 11291 | Guide Finger Clamp Bar Carrier Latch Spring |
| 204233 | 10473 | Guide Finger Clamp Bar Carrier Latch Spring 204230 with 200802E |
| 204364 | 10473 | Guide Finger Clamp Bar Carrier Position Guide with 200078H and 200387C |
| 200078H | 10473 | Guide Finger Clamp Bar Carrier Position Guide Pinch Screw |
| 200387C | 10473 | Guide Finger Clamp Bar Carrier Position Guide Screw |
| 204363 | 10473 | Guide Finger Clamp Bar Carrier Position Guide Slide |
| 200577H | 10473 | Guide Finger Clamp Bar Carrier Position Guide Slide Screw |
| 200785D | 14104 | Guide Finger Clamp Bar Carrier Screw (handle) |
| 200875 | 10473 | Guide Finger Clamp Bar Carrier Screw 200785D with 201537H |
| 201537H | 10473 | Guide Finger Clamp Bar Carrier Screw (handle) Nut |
| 204365 | 10473 | Guide Finger Clamp Bar Carrier Spring |
| 204366 | 10473 | Guide Finger Clamp Bar Position Guide with 200149H |
| 200140H | 11290 | Guide Finger Clamp Bar Position Guide Screw |
| 204367 | 10473 | Guide Finger Clamp Bar Spring .. |
| 200103D | 10473 | " " " Pinch Screw .. |
| 200136F | 14104 | " " " Screw |

| No. | Plate | Name |
|---------|-------|---|
| 204368 | 10473 | Guide Finger Suspending Stop (adjustable) |
| 200118F | 11290 | Guide Finger Suspending Stop Screw |
| 202603 | 11290 | Guide Finger Suspending Stop Screw Washer |
| *203463 | — | Hook (sewing) |
| 203464 | 11241 | " 203463 with 201253F, 201376F and 203251 |
| 203465 | 11241 | Hook and Bobbin Case complete, Nos. 203217 and 203464 |
| 203241 | 11007 | Hook Bevel Gear Socket, 24 teeth |
| 200555H | 11007 | " " " " Screw ... |
| 203242 | 11007 | " " Pinion, 24 teeth, with two 200383C |
| 200383C | 12311 | Hook Bevel Pinion Set Screw |
| 203243 | 11281 | " Counter Shaft |
| 203244 | 11007 | " " " Collar with two 200393C |
| 200393C | 11007 | Hook Counter Shaft Collar Set Screw |
| 203245 | 11007 | Hook Counter Shaft Driving Gear, 44 teeth, with 200362C and 200439C |
| 200439C | 12311 | Hook Counter Shaft Driving Gear Position Screw |
| 200362C | 12311 | Hook Counter Shaft Driving Gear Set Screw |
| 203246 | 11007 | Hook Counter Shaft Gear, 22 teeth, with two 200383C |
| 200383C | 12311 | Hook Counter Shaft Gear Set Screw |
| 202299 | — | " " " Oil Packing (wick) |
| 200840E | 11007 | Hook Counter Shaft Oil Packing (wick) Stop Screw |
| 203247 | 11281 | Hook Driving Shaft |
| 203248 | 11288 | " " " Bearing with 202299 |
| 202299 | — | Hook Driving Shaft Bearing Oil Packing (wick) |
| 202126 | 11285 | Hook Driving Shaft Bearing Position Pin |
| 200516E | 12311 | Hook Driving Shaft Bearing Screw |
| 203249 | 11007 | " " " Bushing (eccentric) |
| 202299 | — | Hook Driving Shaft Bushing Oil Packing (wick) |
| 200362C | 12311 | Hook Driving Shaft Bushing Set Screw |
| 213141 | 11282 | Hook Driving Shaft Collar with two 200393C |

| No. | Plate | Name |
|---------|-------|--|
| 200393C | 11007 | Hook Driving Shaft Collar Set Screw |
| 203251 | 11284 | Hook Gib |
| 201376F | 14104 | " " Hinge Screw |
| 201253F | 14104 | " " Screw |
| 203252 | 11288 | " Saddle with 202299 |
| 202299 | — | " " Oil Packing (wick) |
| 200019E | 11285 | " " Screw (2) |
| 202622 | 11285 | " " Washer (2) |
| 203718 | 11241 | " Washer |
| 203466 | 11288 | Hook Saddle complete, Nos. 200555H, 203241, 203252, 203465 and 203718 |
| 228184 | 14108 | Knee Lifter Connection Lever with 202446 |
| 200224H | 11285 | Knee Lifter Connection Lever Hinge Screw |
| 213879 | 14108 | Knee Lifter Connection Lever Lifting Rod with 202302 |
| 202302 | 14104 | Knee Lifter Connection Lever Lifting Rod Cotter Pin |
| 202446 | 14101 | Knee Lifter Connection Lever Pin |
| 228181 | 14102 | " " Lifting Lever |
| 228183 | — | " " " " 228181 with 201178H, 201527H and 228182 ... |
| 228182 | 14102 | Knee Lifter Lifting Lever Bracket |
| 200570E | 12311 | " " " " " " Screw |
| 201178H | 14103 | Knee Lifter Lifting Lever Hinge Screw |
| 201527H | 14103 | Knee Lifter Lifting Lever Hinge Screw Nut |
| 207807 | 10620 | Knife |
| 204369 | 11291 | " Bar (hollow) |
| 213774 | — | " " 204369 with 200094E, 202603 and 204342 |
| 204372 | 11291 | Knife Bar Collar with two 200387C |
| 200387C | 10473 | " " " Set Screw |
| 213780 | 11289 | " " Driving Bar with two 200585H |
| 200585H | 11285 | Knife Bar Driving Bar Screw |
| 213178 | 11291 | " " " Collar with 200381C and 200387C |
| 213772 | — | Knife Bar Driving Collar 213178 with 200097C, 200243E, 200252C, 213179, 213181, 213628 and two 201528E |
| 200381C | 11291 | Knife Bar Driving Collar Screw .. |
| 200387C | 10473 | " " " " Set Screw |
| 213635 | 11052 | " " " Eccentric with 200382C and 200437C |

| No. | Plate | Name |
|---------|-------|---|
| 202890 | 11290 | Knife Bar Driving Eccentric Fork with 200382C and 201464C |
| 201464C | 14103 | Knife Bar Driving Eccentric Fork Position Screw |
| 200382C | 11285 | Knife Bar Driving Eccentric Fork Set Screw |
| 200437C | 12311 | Knife Bar Driving Eccentric Position Screw |
| 200382C | 11285 | Knife Bar Driving Eccentric Set Screw |
| 213181 | 11291 | Knife Bar Driving Link |
| 213179 | 11291 | " " " " Bracket ... |
| 200243E | 11285 | " " " " " Hinge Screw |
| 201528E | 11285 | Knife Bar Driving Link Bracket Hinge Screw Nut |
| 200252C | 11291 | Knife Bar Driving Link Hinge Screw |
| 201528E | 11285 | Knife Bar Driving Link Hinge Screw Nut |
| 202891 | 11289 | Knife Bar Driving Shaft Crank with 200694C and 201525E |
| 200694E | 11290 | Knife Bar Driving Shaft Crank Screw Stud |
| 201525E | 11290 | Knife Bar Driving Shaft Crank Screw Stud Nut |
| 213628 | 11291 | Knife Bar Handle |
| 200097C | 11291 | " " " Screw |
| 204373 | 11291 | " " Position Guide with 200890 |
| 200026D | 11291 | Knife Bar Position Guide Pinch Screw |
| 200890 | 11291 | Knife Bar Position Guide Pinch Screw 200026D with 201534H |
| 201534H | 11293 | Knife Bar Position Guide Pinch Screw Nut |
| 200028H | 11290 | Knife Bar Position Guide Screw .. |
| 204411 | 11290 | " " Sleeve (split) |
| 200043C | 12311 | " " " Set Screw |
| 200888 | 11291 | " " " " " 200043C with 201524E |
| 201524E | 11291 | Knife Bar Sleeve Set Screw Nut .. |
| 214053 | 11291 | " " Throw-out Spring |
| 200047D | 14104 | " " " " Screw (lower) |
| 200301E | 11291 | Knife Bar Throw-out Spring Screw (upper) |

| No. | Plate | Name |
|---------|-------|--|
| 204381 | --- | Knife Holder |
| 204342 | 11291 | " " 204381 with two 200126F |
| 200094F | 11291 | " " " Screw |
| 202603 | 11290 | " " " Washer |
| 200126F | 11290 | " Screw |
| 202898 | 11289 | " Switch-out Handle with two 200403c |
| 200403c | 14103 | Knife Switch-out Handle Set Screw |
| 202899 | 11290 | " " " Shaft |
| 202900 | 11290 | " " " Spring (spiral) |
| 204383 | 11289 | Needle Bar (hollow) with 200125c, 200175b and 204250 |
| 207072 | 14104 | Needle Bar Bushing (2) |
| 200398c | 14104 | " " " Set Screw (2) .. |
| 204248 | 11292 | " " " Connecting Link |
| 200658c | 11292 | " " " " Hinge Screw Stud |
| 201519E | 11292 | Needle Bar Connecting Link Hinge Screw Stud Nut |
| 204249 | 11292 | Needle Bar Connecting Stud with 200072c and 202277 |
| 202277 | --- | Needle Bar Connecting Stud Oil Packing (wick) |
| 200072c | 11292 | Needle Bar Connecting Stud Pinch Screw |
| 204250 | 11292 | Needle Bar Thread Guide |
| 200175b | 11284 | " " " " Screw .. |
| 200125F | 11292 | " Set Screw |
| 207072 | 14104 | Presser Bar Bushing |
| 200398c | 14104 | " " " Set Screw |
| 202339 | 14104 | " " " Lifter |
| 200653c | 14104 | " " " Hinge Screw ... |
| 204455 | 11287 | " " " Lifting Bracket with 200387c |
| 213667 | 14104 | Presser Bar Lifting Bracket Posi- tion Guide with 200075b and 203551 |
| 200075b | 11292 | Presser Bar Lifting Bracket Posi- tion Guide Screw |
| 203551 | 11292 | Presser Bar Lifting Bracket Posi- tion Guide Screw Bushing |
| 200362c | 12311 | Presser Bar Lifting Bracket Posi- tion Guide Set Screw |
| 200387c | 10473 | Presser Bar Lifting Bracket Set Screw |
| 204258 | 11292 | Presser Bar Spring (heavy) |
| 200494B | 14104 | " " " Thumb Screw (pres- sure regulating) |

| No. | Plate | Name |
|---------|-------|--|
| 201907 | 11293 | Roller Presser, 1 $\frac{1}{2}$ in. diam., $\frac{5}{8}$ in. face (fine), with 200548c and 201534u |
| 202839 | 11293 | Roller Presser Arm |
| 204569 | 11293 | " " " 202839 with 201907 |
| 202560 | 11293 | Roller Presser Arm Bracket (swing) |
| 204436 | ----- | " " " " 250560 with 200096b and 204569 |
| 200675F | 11293 | Roller Presser Arm Bracket Posi- tion Screw Stud |
| 202558 | 11293 | Roller Presser Arm Bracket Spring |
| 202559 | 11293 | " " " " " " Stop |
| 200141F | 11293 | Roller Presser Arm Bracket Spring Stop Screw |
| 200096b | 11293 | Roller Presser Arm Screw |
| 204495 | 11289 | " " Bar |
| 200548c | 11293 | " " Hinge Screw |
| 201534u | 11293 | " " " " Nut |
| 204437 | --- | Roller Presser and Bar complete, Nos. 200675F, 202558, 202559, 204436, 204495 and two 200141F.. |
| 213006 | 11288 | Take-up Cam with 200335c, 200383c, 200430c, 200658c and 201519E ... |
| 203172 | 11292 | Take-up Cam Friction Washer |
| 200430c | 12311 | " " Position Screw |
| 200383c | 12311 | " " " " Check Screw |
| 200335c | 12311 | Take-up Cam Set Screw |
| 203270 | 11292 | " Lever |
| 203291 | ----- | " " 203270 with 204263 ... |
| 204263 | 11292 | " " Bearing with 204264 .. |
| 204264 | 11292 | " " " Position Pin ... |
| 200042F | 12311 | " " " Screw |
| 201816 | 11292 | " " Roller |
| 203271 | 11292 | Take-up Lever complete, Nos. 200042F, 201816 and 203291 |
| 244007 | 12349 | Tension Disc |
| 202090 | 12349 | " " Position Pin |
| 223423 | 14107 | " Release Lever |
| 200309E | 12349 | " " " Screw |
| 202075 | 12349 | " " Plunger |
| 223427 | 14107 | " " Slide |
| 204457 | 14104 | " " " Spring |
| 202737 | 14104 | " " " " Adjusting Collar with 200380c |
| 200380c | 14107 | Tension Release Slide Spring Ad- justing Collar Set Screw |

| No. | Plate | Name |
|---------|-------|--|
| 202407 | 10881 | Tension Spring |
| 200632B | 12349 | " Stud |
| 200397H | 12349 | " " Set Screw |
| 201572B | 10881 | " Thumb Nut |
| 204271 | 12349 | " Washer |
| 204272 | 12249 | Tension complete, Nos. 200632B, 201572B, 202075, 202407, 204271 and two 244007 |
| 204274 | 12349 | Thread Controller Plate |
| 200577H | 10473 | " " " Screw |
| 202098 | 12349 | " " Roller |
| 204275 | 12249 | " " " Guard |
| 202084 | 12249 | " " " " Washer |
| 200300C | 12349 | " " " Screw |
| 204276 | 12349 | " " Spring |
| 204333 | 12349 | " " " Guard |
| 200581H | 12349 | " " " " Screw |
| 202087 | 12349 | " " " Stop |
| 202088 | 12349 | " " " Stud with 204925 |
| 200366H | 12349 | Thread Controller Spring Stud Set Screw |
| 204925 | 11292 | Thread Controller Spring Stud Washer |
| 205987 | 12349 | Thread Controller complete, Nos. 200300C, 200581H, 202084, 202098, 204274, 204275 and 204333 |
| 204280 | 12349 | Thread Controller and Spring com- plete, Nos. 204276 and 205987 |
| 202412 | 11292 | Thread Guide |
| 202413 | 11292 | " " |
| 202091 | 12349 | " Retainer Sleeve |
| 202092 | 12349 | " " Spring |
| 204058 | 12349 | " " Stud |
| 200368H | 12349 | " " " Set Screw |
| 204059 | 12349 | Thread Retainer complete, Nos. 202091, 202092 and 204058 |
| 213163 | 14102 | Throat Plate Adjusting Lever with 200627E, 201539E, 204387 and two 200479F |
| 200264D | 11052 | Throat Plate Adjusting Lever Hinge Screw |
| 200479F | 11052 | Throat Plate Adjusting Lever Posi- tion Screw |
| 200627E | 11052 | Throat Plate Adjusting Lever Screw Stud |
| 201539E | 11052 | Throat Plate Adjusting Lever Screw Stud Nut |
| 201556D | 14103 | Throat Plate Adjusting Lever Screw Stud Thumb Nut |

| No. | Plate | Name |
|---------|-------|--|
| 213112 | 14101 | Throat Plate Adjusting Lever Screw Stud Thumb Nut Washer Plate |
| 203152 | 14103 | Throat Plate Adjusting Lever Screw Stud Thumb Nut Washer Plate Pin (2) |
| 223443 | 14106 | Throat Plate Body |
| 207464 | 12059 | " " Knife Cutting Bar, 53 needle hole, for needle sizes 12 and 13, trims back of needle and .015 in. to right of seam |
| 200583H | 14107 | Throat Plate Knife Cutting Bar Screw |
| 200585H | 11285 | Throat Plate Screw (2) |
| 213162 | 14102 | " " Slide Plate (adjustable) |
| 204387 | 14101 | " " " " Position Stud |
| 200306D | 11052 | " " " " Screw (2) .. |
| 211493 | 12061 | Throat Plate complete, 53 needle hole, for needle sizes 12 and 13, trims back of needle and .015 in. to right of seam, Nos. 207464, 223443 and two 200583H |

MACHINE No. 29w23

DROP FEED. OBLIQUE UNDEREDGE TRIMMER

For Leather

The same as Machine No. 29w15 with the following exceptions:

| No. | Plate | Name |
|--------|-------|--|
| 204355 | 11291 | Guide Finger, in place of 204356 .. |
| 223443 | 14106 | Throat Plate Body, in place of 223444 |
| 207464 | 12059 | Throat Plate Knife Cutting Bar, 53 needle hole, for needle sizes 12 and 13, trims back of needle and .015 in. to right of seam, in place of 207470 |
| 211493 | 12061 | Throat Plate complete, 53 needle hole, for needle sizes 12 and 13, trims back of needle and .015 in. to right of seam, Nos. 207464, 223443 and two 200583u, in place of 211499 |

MACHINE No. 29w27

DROP FEED. OBLIQUE UNDEREDGE TRIMMER

For Leather

Same as Machine No. 29w17 with the following exceptions:

| No. | Plate | Name |
|--------|-------|--|
| 204355 | 11291 | Guide Finger, in place of 204356 .. |
| 223445 | 14106 | Throat Plate Body, in place of 223446 |
| 207464 | 12059 | Throat Plate Knife Cutting Bar, 53 needle hole, for needle sizes 12 and 13, trims back of needle and .015 in. to right of seam, in place of 207470 |
| 211515 | 12065 | Throat Plate complete, 53 needle hole, for needle sizes 12 and 13, trims back of needle and .015 in. to right of seam, Nos. 207464, 223445 and two 200583u, in place of 211521 |

ACCESSORIES

FOR MACHINE No. 29w2

| No. | Plate | Name |
|---------|-------|--|
| 203208 | 11284 | Bobbin (5) |
| *225482 | --- | " Case Screw Driver Blade .. |
| *225483 | --- | " " " " Handle .. |
| 225497 | 12153 | Bobbin Case Screw Driver complete, Nos. 225482 and 225483 .. |
| 225487 | 14104 | Roller Presser Hinge Screw Nut Wrench |
| 207805 | 10620 | Trimmer Knife (3) |
| 128 x 4 | --- | Needles, two each, sizes 11, 12 and 13 |
| 228212 | --- | Drip Pan with four 1 in. wire nails |
| 41400 | 12153 | Machine Rest Pin (wood) |
| 120342 | 12153 | Oiler (copper plated) with 120343 .. |
| 120343 | 12153 | " Spout, 3½ in. long |
| *225484 | --- | Screw Driver Blade |
| *225485 | --- | " " Handle |
| 225498 | 12153 | Screw Driver complete (7¼ in. long), Nos. 225484 and 225485 .. |
| 225554 | 12153 | Wrench (steel) |

BOBBIN WINDER

Swing Automatic, Right Hand

| | | |
|---------|-------|----------------------------------|
| 225453 | 10884 | Frame with 202277 and 225438 ... |
| 225454 | 10884 | " Hinge Pin |
| 202277 | --- | " Oil Packing (wick) |
| 225438 | 10884 | " " Well Cap |
| 225455 | 10884 | " Spring |
| 225456 | 10884 | " " Plunger |
| 202473 | 10885 | Pulley with 200380c |
| 200380c | 14107 | " Set Screw |
| 225381 | 10884 | Spindle |
| 225444 | 10884 | Stop Latch |
| 200056E | 10884 | " " Screw |
| 225458 | 10884 | " " Thumb Lever |
| 225459 | 10884 | " " " " Hinge Stud |
| 225459 | 10884 | " " " " Joint Stud |
| 202478 | 10884 | " " Trip Lever |
| 200299H | 10884 | " " " " Hinge Screw |

| No. | Plate | Name |
|---------|-------|--|
| 225461 | 10881 | Tension Bracket with 201499B |
| 200082D | 10881 | " " " Screw |
| 228026 | 10884 | " " " Washer |
| 2102 | 10881 | " Disc |
| 202407 | 10881 | " Spring |
| 201499B | 10881 | " Stud |
| 201572B | 10881 | " " Thumb Nut |
| 225462 | 10881 | Bobbin Winder Tension Bracket complete, Nos. 201572B, 202407, 225461 and two 2102 |
| 225433 | 10885 | Bobbin Winder and Tension Bracket Base |
| 225382 | 10885 | Universal Bobbin Winder complete, Nos. 200056E, 200082D, 200299H, 202473, 202478, 225381, 225433, 225444, 225453 to 225456, 225458, 225462, 228026, two each 225459 and wood screws ¾ in., No. 12, R.H.B. |

KNEE LIFTER

| | | |
|---------|-------|---|
| 2763 | 14171 | Rock Shaft |
| 7539 | 14171 | " " Hanger (back) with two wood screws 1 in., No. 10 |
| 20093 | 14171 | Rock Shaft Hanger (front) with two wood screws 1 in., No. 10 .. |
| 2765 | 14171 | Rock Shaft Knee Arm |
| 2768 | --- | " " " " 2765 with 2766 and 2767 |
| 2766 | 14171 | Rock Shaft Knee Arm Hub with 356c |
| 356c | 14171 | Rock Shaft Knee Arm Hub Set Screw |
| 2767 | 14171 | Rock Shaft Knee Plate with 356c .. |
| 356c | 14171 | " " " " Set Screw .. |
| 228238 | 14171 | " " Lifting Lever with 356c |
| 228239 | --- | " " " " 228238 with 8073, 204225, 228240 and 228241 .. |
| 228240 | 14171 | Rock Shaft Lifting Lever Rod (3 in. long) |
| 200529c | 14171 | Rock Shaft Lifting Lever Rod Set Screw |
| 228241 | 14171 | Rock Shaft Lifting Lever Rod Swivel with 200529c |

| No. | Plate | Name |
|--------|-------|--|
| 204225 | 14171 | Rock Shaft Lifting Lever Rod Swivel Spring |
| 8073 | 14171 | Rock Shaft Lifting Lever Rod Swivel Spring Plunger |
| 356c | 14171 | Rock Shaft Lifting Lever Set Screw |
| 2770 | 14171 | " " Stop Dog with 356c ... |
| 356c | 14171 | " " " " Set Screw .. |
| 228242 | 14171 | Rock Shaft complete, Nos. 2763, 2768, 7539, 20093, 228239 and two 2770 |

FOR MACHINES NOS. 29w6 AND 29w14

Same as for No. 29w2 with the following exception:

| No. | Plate | Name |
|--------|-------|-------------------------------------|
| 203470 | 11284 | Bobbin (5), in place of 203208 |

FOR MACHINE No. 29w11

Same as for No. 29w2 with the following exception:

| | | |
|---------|-----|--|
| 128 x 6 | --- | Needles, six, size 16 (reverse twist), in place of 128 x 4 |
|---------|-----|--|

FOR MACHINES NOS. 29w15, 29w21 AND 29w23

Same as for No. 29w2 with the following exception:

| | | |
|--------|-------|---|
| 207807 | 10620 | Trimmer Knife (3), in place of 207805 |
|--------|-------|---|

FOR MACHINES NOS. 29w17 AND 29w27

Same as for No. 29w2 with the following exceptions:

| | | |
|--------|-------|---|
| 203470 | 11284 | Bobbin (5), in place of 203208 |
| 207807 | 10620 | Trimmer Knife (3), in place of 207805 |

FEED DOGS

| No. | Plate | Name |
|--------|-------|---|
| 207651 | 14106 | Feed Dog, for 211292, 211420, 211422, 211451 to 211454, 211463 to 211466, 211483, 211484, 211489 to 211503, 211515 to 211525, 211605, 223432 and 223433 |
| 211597 | 14106 | Feed Dog, for 211292, 211420, 211422, 211451 to 211454, 211463 to 211466, 211483, 211484, 211489 to 211503, 211515 to 211525, 211605, 223432 and 223433 |
| 211255 | 12024 | Feed Dog, for 211421, 211447 to 211450, 211481 and 211482 |
| 211256 | 12024 | Feed Dog, for 211421, 211448 to 211450, 211481 and 211482 |

FEED WHEELS

| | | |
|--------|-------|---|
| 204303 | 11288 | Feed Wheel, for 204425, 211292, 211420, 211422, 211451 to 211454, 211463 to 211466, 211483, 211484, 211489 to 211503, 211515 to 211525, 211605, 223432 and 223433 |
| 204429 | 11288 | Feed Wheel, for 204433, 211245, 211250, 211284 to 211288, 211455 to 211462, 211485, 211486 and 211973 |

ROLLER PRESSERS

| No. | Plate | Name |
|---------|-------|--|
| 201907 | 11293 | Roller Presser, 1 $\frac{1}{4}$ in. diam., $\frac{5}{16}$ in. face (fine), with 200548c and 201534u |
| 201910 | 11293 | Roller Presser, 1 $\frac{1}{4}$ in. diam., $\frac{1}{4}$ in. face (coarse) with 200551c and 201534u |
| 208497 | 11293 | Roller Presser Arm |
| 208498 | --- | " " " 208497 with 201910 |
| 202839 | 11293 | Roller Presser Arm |
| 204569 | 11293 | " " " 202839 with 201907 |
| 202560 | 11293 | Roller Presser Arm Bracket (swing) |
| 208499 | --- | " " " " 202560 with 200096D and 208498 |
| 204436 | --- | Roller Presser Arm Bracket 202560 with 200096D and 204569 |
| 200675F | 11293 | Roller Presser Arm Bracket Position Screw Stud |
| 202558 | 11293 | Roller Presser Arm Bracket Spring |
| 202559 | 11293 | " " " " " " Stop |
| 200141F | 11293 | Roller Presser Arm Bracket Spring Stop Screw |
| 200096D | 11293 | Roller Presser Arm Screw |
| 204495 | 11289 | " " Bar |
| 200551c | 11293 | " " Hinge Screw |
| 200548c | 11293 | " " " " " " |
| 201534u | 11293 | " " " " " Nut |
| 204576 | --- | Roller Presser and Bar complete, Nos. 200675F, 202558, 202559, 204495, 208499 and two 200141F, for Machines Nos. 29w2, 29w6 and 29w14 |
| 204437 | --- | Roller Presser and Bar complete, Nos. 200675F, 202558, 202559, 204436, 204495 and two 200141F, for Machines Nos. 29w11, 29w15, 29w17, 21w21, 29w23 and 29w27 |

THROAT PLATES

FOR VERTICAL TRIMMER MACHINE No. 29w2

| No. | Plate | Name |
|---------|-------|---|
| 211424 | 12024 | Throat Plate Knife Follower |
| 200587D | 14103 | " " " " Screw .. |
| 211416 | 12024 | " " " " Spring .. |
| 200178D | 14103 | " " " " " " Screw |
| 211451 | 12058 | Throat Plate, 60 needle hole, for needle sizes 8 and 9, with 200178D, 200587D, 211416 and 211424, trims opposite the needle and .028, .035, .045, .060 and .085 in. to right of seam, for 204303, 207651 and 211597 |
| 211452 | 12058 | Throat Plate, 56 needle hole, for needle sizes 10 and 11, with 200178D, 200587D, 211416 and 211424, trims opposite the needle and .035, .045, .060 and .085 in. to right of seam, for 204303, 207651 and 211597 |
| 211453 | 12058 | Throat Plate, 53 needle hole, for needle sizes 12 and 13, with 200178D, 200587D, 211416 and 211424, trims opposite the needle and .045, .060 and .085 in. to right of seam, for 204303, 207651 and 211597 |
| 211454 | 12058 | Throat Plate, 50 needle hole, for needle sizes 14 and 15, with 200178D, 200587D, 211416 and 211424, trims opposite the needle and .060 and .085 in. to right of seam, for 204303, 207651 and 211597 |
| 211292 | 12058 | Throat Plate, 46 needle hole, for needle sizes 16 and 18, with 200178D, 200587D, 211416 and 211424, trims opposite the needle and .060 and .085 in. to right of seam, for 204303, 207651 and 211597 |

| No. | Plate | Name |
|--------|-------|---|
| 211455 | 12058 | Throat Plate, 60 needle hole, for needle sizes 8 and 9, with 200178D, 200587D, 211416 and 211424, trims opposite the needle and .028, .035, .045, .060 and .085 in. to right of seam, for 204429 .. |
| 211456 | 12058 | Throat Plate, 56 needle hole, for needle sizes 10 and 11, with 200178D, 200587D, 211416 and 211424, trims opposite the needle and .035, .045, .060 and .085 in. to right of seam, for 204429 |
| 211457 | 12058 | Throat Plate, 53 needle hole, for needle sizes 12 and 13, with 200178D, 200587D, 211416 and 211424, trims opposite the needle .045, .060 and .085 in. to right of seam, for 204429 |
| 211458 | 12058 | Throat Plate, 50 needle hole, for needle sizes 14 and 15, with 200178D, 200587D, 211416 and 211424, trims opposite the needle and .060 and .085 in. to right of seam, for 204429 |
| | | Nos. 211459 to 211462, for glove work |
| 211459 | 12058 | Throat Plate, 60 needle hole, for needle sizes 8 and 9, with 200178D, 200587D, 211416 and 211424, trims opposite the needle and .028, .035, .045, .060 and .085 in. to right of seam, for 204429 .. |
| 211460 | 12058 | Throat Plate, 56 needle hole, for needle sizes 10 and 11, with 200178D, 200587D, 211416 and 211424, trims opposite the needle and .035, .045, .060 and .085 in. to right of seam, for 204429 |
| 211461 | 12058 | Throat Plate, 53 needle hole, for needle sizes 12 and 13, with 200178D, 200587D, 211416 and 211424, trims opposite the needle and .045, .060 and .085 in. to right of seam, for 204429 |
| 211462 | 12058 | Throat Plate, 50 needle hole, for needle sizes 14 and 15, with 200178D, 200587D, 211416 and 211424, trims opposite the needle and .060 and .085 in. to right of seam, for 204429 |

FOR VERTICAL TRIMMER MACHINE No. 29w6

| No. | Plate | Name |
|--------|-------|---|
| 211422 | 12064 | Throat Plate, 60 needle hole, for needle sizes 8 and 9, with 200178D, 200587D, 211416 and 211424, trims opposite the needle and .028, .035, .045, .060 and .085 in. to right of seam, for 207651 and 211597 |
| 211420 | 12064 | Throat Plate, 56 needle hole, for needle sizes 10 and 11, with 200178D, 200587D, 211416 and 211424, trims opposite the needle and .035, .045, .060 and .085 in. to right of seam, for 207651 and 211597 |
| 211483 | 12064 | Throat Plate, 53 needle hole, for needle sizes 12 and 13, with 200178D, 200587D, 211416 and 211424, trims opposite the needle and .045, .060 and .085 in. to right of seam, for 207651 and 211597.. |
| 211484 | 12064 | Throat Plate, 50 needle hole, for needle sizes 14 and 15, with 200178D, 200587D, 211416 and 211424, trims opposite the needle and .060 and .085 in. to right of seam, for 207651 and 211597 |
| 211605 | 12064 | Throat Plate, 46 needle hole, for needle sizes 16 and 18, with 200178D, 200587D, 211416 and 211424, trims opposite the needle and .060 and .085 in. to right of seam, for 207651 and 211597 |

FOR VERTICAL TRIMMER MACHINE No. 29w11

| | | |
|--------|-------|---|
| 211453 | 12058 | Throat Plate, 53 needle hole, for needle sizes 12 and 13, with 200178D, 200587D, 211416 and 211424, trims opposite the needle and .045, .060 and .085 in. to right of seam, for 204303, 207651 and 211597 |
|--------|-------|---|

| No. | Plate | Name |
|--------|-------|--|
| 211454 | 12058 | Throat Plate, 50 needle hole, for needle sizes 14 and 15, with 200178D, 200587D, 211416 and 211424, trims opposite the needle and .060 and .085 in. to right of seam, for 204303, 207651 and 211597 |
| 211292 | 12058 | Throat Plate, 46 needle hole, for needle sizes 16 and 18, with 200178D, 200587D, 211416 and 211424, trims opposite the needle and .060 and .085 in. to right of seam, for 204303, 207651 and 211597 |
| 211457 | 12058 | Throat Plate, 53 needle hole, for needle sizes 12 and 13, with 200178D, 200587D, 211416 and 211424, trims opposite the needle and .045, .060 and .085 in. to right of seam, for 204429 |
| 211458 | 12058 | Throat Plate, 50 needle hole, for needle sizes 14 and 15, with 200178D, 200587D, 211416 and 211424, trims opposite the needle and .060 and .085 in. to right of seam, for 204429 |
| 211461 | 12058 | Throat Plate, 53 needle hole, for needle sizes 12 and 13, with 200178D, 200587D, 211416 and 211424, trims opposite the needle and .045, .060 and .085 in. to right of seam, for glove work, for 204429 |
| 211462 | 12058 | Throat Plate, 50 needle hole, for needle sizes 14 and 15, with 200178D, 200587D, 211416 and 211424, trims opposite the needle and .060 and .085 in. to right of seam, for glove work, for 204429 |

FOR VERTICAL TRIMMER MACHINE No. 29w14

| | | |
|--------|-------|--|
| 211422 | 12064 | Throat Plate, 60 needle hole, for needle sizes 8 and 9, with 200178D, 200587D, 211416 and 211424, trims opposite the needle and .028, .035, .045, .060 and .085 in. to right of seam, for 204303.. |
|--------|-------|--|

| No. | Plate | Name |
|--------|-------|---|
| 211420 | 12064 | Throat Plate, 56 needle hole, for needle sizes 10 and 11, with 200178D, 200587D, 211416 and 211424, trims opposite the needle and .035, .045, .060 and .085 in. to right of seam, for 204303 |
| 211483 | 12064 | Throat Plate, 53 needle hole, for needle sizes 12 and 13, with 200178D, 200587D, 211416 and 211424, trims opposite the needle and .045, .060 and .085 in. to right of seam, for 204303 |
| 211484 | 12064 | Throat Plate, 50 needle hole, for needle sizes 14 and 15, with 200178D, 200587D, 211416 and 211424, trims opposite the needle and .060 and .085 in. to right of seam, for 204303 |
| 211605 | 12064 | Throat Plate, 46 needle hole, for needle sizes 16 and 18, with 200178D, 200587D, 211416 and 211424, trims opposite the needle and .060 and .085 in. to right of seam, for 204303 |
| 211287 | 12024 | Throat Plate, 60 needle hole, for needle sizes 8 and 9, with 200178D, 200587D, 211416 and 211424, trims opposite the needle and .028, .035, .045, .060 and .085 in. to right of seam, for 204429 .. |
| 211245 | 12024 | Throat Plate, 56 elongated needle hole, for needle sizes 12 and 13, with 200178D, 200587D, 211416 and 211424, trims opposite the needle and .035, .045, .060 and .085 in. to right of seam, for 204429 |
| 211284 | 12024 | Throat Plate, 53 elongated needle hole, for needle sizes 14 and 15, with 200178D, 200587D, 211416 and 211424, trims opposite the needle and .045, .060 and .085 in. to right of seam, for 204429 |
| 211288 | 12024 | Throat Plate, 50 elongated needle hole, for needle sizes 16 and 18, with 200178D, 200587D, 211416 and 211424, trims opposite the needle and .060 and .085 in. to right of seam, for 204429 |

Throat Plates

| No. | Plate | Name |
|--------|-------|--|
| 211250 | 12024 | Throat Plate, 46 elongated needle hole, for needle sizes 20 and 22, with 200178D, 200587D, 211416 and 211424, trims opposite the needle and .060 and .085 in. to right of seam, for 204429 |
| 211485 | 12064 | Throat Plate, 60 needle hole, for needle sizes 8 and 9, with 200178D, 200587D, 211416 and 211424, trims opposite the needle and .028, .035, .045, .060 and .085 in. to right of seam, for glove work, for 204429 |
| 211486 | 12064 | Throat Plate, 56 needle hole, for needle sizes 10 and 11, with 200178D, 200587D, 211416 and 211424, trims opposite the needle and .035, .045, .060 and .085 in. to right of seam, for glove work, for 204429 |
| 211285 | 12064 | Throat Plate, 53 elongated needle hole, for needle sizes 14 and 15, with 200178D, 200587D, 211416 and 211424, trims opposite the needle and .045, .060 and .085 in. to right of seam, for glove work, for 204429 |
| 211973 | 12064 | Throat Plate, 50 needle hole, for needle sizes 14 and 15, with 200178D, 200587D, 211416 and 211424, trims opposite the needle and .060 and .085 in. to right of seam, for 204429 |
| 211286 | 12064 | Throat Plate, 46 elongated needle hole, for needle sizes 20 and 22, with 200178D, 200587D, 211416 and 211424, trims opposite the needle and .060 and .085 in. to right of seam, for glove work, for 204429 |

FOR UNDEREDGE TRIMMER MACHINE No. 29w15

| | | |
|--------|-------|---|
| 211465 | 12059 | Throat Plate, 53 needle hole, for needle sizes 12 and 13, with 200178D, 200587D, 211416 and 211540, trims opposite the needle and .040, .050, .060, .075 and .085 in. to right of seam, for 204303, 207651 and 211597 |
|--------|-------|---|

Throat Plates

| No. | Plate | Name |
|---------|-------|---|
| 211466 | 12059 | Throat Plate, 50 needle hole, for needle sizes 14 and 15, with 200178D, 200587D, 211416 and 211540, trims opposite the needle and .050, .060, .075 and .085 in. to right of seam, for 204303, 207651 and 211597 |
| 223444 | 14106 | Throat Plate Body, for trimming opposite the needle and .035, .040 or .050 in. to right of seam, for 211499 to 211501 and 223433 |
| 211468 | 12059 | Throat Plate Body, for trimming opposite the needle and .060 or .075 in. to right of seam, for 211502 and 211503 |
| 211540 | 14106 | Throat Plate Knife Follower |
| 207487 | 12069 | " " " Cutting Bar, 56 needle hole, for needle sizes 10 and 11, trims opposite the needle and .035 in. to right of seam |
| 223433 | 11299 | Throat Plate complete, 56 needle hole, for needle sizes 10 and 11, trims opposite the needle and .035 in. to right of seam, Nos. 207487, 223444 and two 200583H, for 204303, 207651 and 211597 .. |
| 207470 | 12069 | Throat Plate Knife Cutting Bar, 53 needle hole, for needle sizes 12 and 13, trims opposite the needle and .040 in. to right of seam |
| 200583H | 14107 | Throat Plate Knife Cutting Bar Screw |
| 211499 | 12061 | Throat Plate complete, 53 needle hole, for needle sizes 12 and 13, trims opposite the needle and .040 in. to right of seam, Nos. 207470, 223444 and two 200583H, for 204303, 207651 and 211597 |
| 208496 | 14107 | Throat Plate Knife Cutting Bar, 53 needle hole, for needle sizes 12 and 13, trims opposite the needle and .050 in. to right of seam |
| 211500 | 12061 | Throat Plate complete, 53 needle hole, for needle sizes 12 and 13, trims opposite the needle and .050 in. to right of seam, Nos. 208496, 223444 and two 200583H, for 204303, 207651 and 211597 |

Throat Plates

| No. | Plate | Name |
|--------|-------|--|
| 207463 | 12060 | Throat Plate Knife Cutting Bar, 50 needle hole, for needle sizes 14 and 15, trims opposite the needle and .050 in. to right of seam |
| 211501 | 12061 | Throat Plate complete, 50 needle hole, for needle sizes 14 and 15, trims opposite the needle and .050 in. to right of seam. Nos. 207463, 223444 and two 200583u, for 202403, 207651 and 211597 |
| 207474 | 12060 | Throat Plate Knife Cutting Bar, 50 needle hole, for needle sizes 14 and 15, trims opposite the needle and .060 in. to right of seam |
| 211502 | 12061 | Throat Plate complete, 50 needle hole, for needle sizes 14 and 15, trims opposite the needle and .060 in. to right of seam. Nos. 207474, 211468 and two 200583u, for 204303, 207651 and 211597 |
| 207475 | 12060 | Throat Plate Knife Cutting Bar, 50 needle hole, for needle sizes 14 and 15, trims opposite the needle and .075 in. to right of seam |
| 211503 | 12061 | Throat Plate complete, 50 needle hole, for needle sizes 14 and 15, trims opposite the needle and .075 in. to right of seam. Nos. 207475, 211468 and two 200583u, for 204303, 207651 and 211597 |

FOR UNDEREDGE TRIMMER MACHINE No. 29w17

| | | |
|--------|-------|---|
| 211491 | 12066 | Throat Plate, 53 needle hole, for needle sizes 12 and 13, with 200178D, 200587D, 211416 and 211540, trims opposite the needle and .040, .050, .060, .075 and .085 in. to right of seam, for 204303, 207651 and 211597 |
| 211492 | 12066 | Throat Plate, 50 needle hole, for needle sizes 14 and 15, with 200178D, 200587D, 211416 and 211540, trims opposite the needle and .050, .060, .075 and .085 in. to right of seam, for 204303, 207651 and 211597 |

Throat Plates

| No. | Plate | Name |
|--------|-------|--|
| 211488 | 12065 | Throat Plate Body, for trimming opposite the needle and .060 or .075 in. to right of seam, for 211524 and 211525 |
| 223446 | 14106 | Throat Plate Body, for trimming opposite the needle and .035, .040 or .050 in. to right of seam, for 211521 to 211523 and 223432 |
| 207487 | 12060 | Throat Plate Knife Cutting Bar, 56 needle hole, for needle sizes 10 and 11, trims opposite the needle and .035 in. to right of seam |
| 207470 | 12060 | Throat Plate Knife Cutting Bar, 53 needle hole, for needle sizes 12 and 13, trims opposite the needle and .040 in. to right of seam |
| 223432 | 11299 | Throat Plate complete, 56 needle hole, for needle sizes 10 and 11, trims opposite the needle and .035 in. to right of seam. Nos. 207487, 223446 and two 200583u, for 204303, 207651 and 211597 |
| 211521 | 12065 | Throat Plate complete, 53 needle hole, for needle sizes 12 and 13, trims opposite the needle and .040 in. to right of seam. Nos. 207470, 223446 and two 200583u, for 204303, 207651 and 211597 |
| 211522 | 12065 | Throat Plate complete, 53 needle hole, for needle sizes 12 and 13, trims opposite the needle and .050 in. to right of seam. Nos. 208496, 223446 and two 200583u, for 204303, 207651 and 211597 |
| 208496 | 14107 | Throat Plate Knife Cutting Bar, 53 needle hole, for needle sizes 12 and 13, trims opposite the needle and .050 in. to right of seam .. |
| 207463 | 12060 | Throat Plate Knife Cutting Bar, 50 needle hole, for needle sizes 14 and 15, trims opposite the needle and .050 in. to right of seam |
| 211523 | 12065 | Throat Plate complete, 50 needle hole, for needle sizes 14 and 15, trims opposite the needle and .050 in. to right of seam. Nos. 207463, 223446 and two 200583u, for 204303, 207651 and 211597 |

| No. | Plate | Name |
|--------|-------|--|
| 207474 | 12060 | Throat Plate Knife Cutting Bar, 50 needle hole, for needle sizes 14 and 15, trims opposite the needle and .060 in. to right of seam |
| 211524 | 12065 | Throat Plate complete, 50 needle hole, for needle sizes 14 and 15, trims opposite the needle and .060 in. to right of seam, Nos. 207474, 211488 and two 200583u, for 204303, 207651 and 211597 |
| 207475 | 12060 | Throat Plate Knife Cutting Bar, 50 needle hole, for needle sizes 14 and 15, trims opposite the needle and .075 in. to right of seam |
| 211525 | 12065 | Throat Plate complete, 50 needle hole, for needle sizes 14 and 15, trims opposite the needle and .075 in. to right of seam, Nos. 207475, 211488 and two 200583u, for 204303, 207651 and 211597 |

FOR UNDEREDGE TRIMMER MACHINES
NOS. 29w21 AND 29w23

| | | |
|--------|-------|--|
| 211463 | 12058 | Throat Plate, 53 needle hole, for needle sizes 12 and 13, with 200178D, 200587D, 211416 and 211425, trims back of needle and .015, .025, .035 and .050 in. to right of seam, for 204303, 207651 and 211597 |
| 211464 | 12058 | Throat Plate, 50 needle hole, for needle sizes 14 and 15, with 200178D, 200587D, 211416 and 211425, trims back of needle and .015, .025, .035 and .050 in. to right of seam, for 204303, 207651 and 211597 |
| 223443 | 14106 | Throat Plate Body, for trimming back of needle and .015 or .025 in. to right of seam, for 211493 to 211496 |
| 211467 | 12059 | Throat Plate Body, for trimming back of needle and .035 or .050 in. to right of seam, for 211497 and 211498 |
| 211425 | 12058 | Throat Plate Knife Follower |

| No. | Plate | Name |
|--------|-------|---|
| 207464 | 12059 | Throat Plate Knife Cutting Bar, 53 needle hole, for needle sizes 12 and 13, trims back of needle and .015 in. to right of seam |
| 211493 | 12061 | Throat Plate complete, 53 needle hole, for needle sizes 12 and 13, trims back of needle and .015 in. to right of seam, Nos. 207464, 223443 and two 200583u, for 204303, 207651 and 211597 |
| 207299 | 12059 | Throat Plate Knife Cutting Bar, 50 needle hole, for needle sizes 14 and 15, trims back of needle and .015 in. to right of seam |
| 211494 | 12061 | Throat Plate complete, 50 needle hole, for needle sizes 14 and 15, trims back of needle and .015 in. to right of seam, Nos. 207299, 223443 and two 200583u, for 204303, 207651 and 211597 |
| 207471 | 12059 | Throat Plate Knife Cutting Bar, 53 needle hole, for needle sizes 12 and 13, trims back of needle and .025 in. to right of seam |
| 211495 | 12061 | Throat Plate complete, 53 needle hole, for needle sizes 12 and 13, trims back of needle and .025 in. to right of seam, Nos. 207471, 223443 and two 200583u, for 204303, 207651 and 211597 |
| 207300 | 12059 | Throat Plate Knife Cutting Bar, 50 needle hole, for needle sizes 14 and 15, trims back of needle and .025 in. to right of seam |
| 211496 | 12061 | Throat Plate complete, 50 needle hole, for needle sizes 14 and 15, trims back of needle and .025 in. to right of seam, Nos. 207300, 223443 and two 200583u, for 204303, 207651 and 211597 |
| 207472 | 12060 | Throat Plate Knife Cutting Bar, 50 needle hole, for needle sizes 14 and 15, trims back of needle and .035 in. to right of seam |
| 211497 | 12061 | Throat Plate complete, 50 needle hole, for needle sizes 14 and 15, trims back of needle and .035 in. to right of seam, Nos. 207472, 211467 and two 200583H, for 204303, 207651 and 211597 |

| No. | Plate | Name |
|--------|-------|---|
| 207473 | 12060 | Throat Plate Knife Cutting Bar, 50 needle hole, for needle sizes 14 and 15, trims back of needle and .050 in. to right of seam |
| 211498 | 12061 | Throat Plate complete, 50 needle hole, for needle sizes 14 and 15, trims back of needle and .050 in. to right of seam, Nos. 207473, 211467 and two 200583u, for 204303, 207651 and 211597 |

FOR UNDEREDGE TRIMMER MACHINE No. 29w27

| | | |
|--------|-------|--|
| 211489 | 12066 | Throat Plate, 53 needle hole, for needle sizes 12 and 13, with 200178D, 200587D, 211416 and 211425, trims back of needle and .015, .025, .035 and .050 in. to right of seam, for 204303, 207651 and 211597 |
| 211490 | 12066 | Throat Plate, 50 needle hole, for needle sizes 14 and 15, with 200178D, 200587D, 211416 and 211425, trims back of needle and .015, .025, .035 and .050 in. to right of seam, for 204303, 207651 and 211597 |
| 211487 | 12065 | Throat Plate Body, for trimming back of needle and .035 or .050 in. to right of seam, for 211519 and 211520 |
| 223445 | 14106 | Throat Plate Body, for trimming back of needle and .015 or .025 in. to right of seam, for 211515 to 211518 |
| 207464 | 12059 | Throat Plate Knife Cutting Bar, 53 needle hole, for needle sizes 12 and 13, trims back of needle and .015 in. to right of seam |
| 211515 | 12065 | Throat Plate complete, 53 needle hole, for needle sizes 12 and 13, trims back of needle and .015 in. to right of seam, Nos. 207464, 223445 and two 200583u, for 204303, 207651 and 211597 |
| 207299 | 12059 | Throat Plate Knife Cutting Bar, 50 needle hole, for needle sizes 14 and 15, trims back of needle and .015 in. to right of seam |

| No. | Plate | Name |
|--------|-------|---|
| 211516 | 12065 | Throat Plate complete, 50 needle hole, for needle sizes 14 and 15, trims back of needle and .015 in. to right of seam, Nos. 207299, 223445 and two 200583u, for 204303, 207651 and 211597 |
| 207471 | 12059 | Throat Plate Knife Cutting Bar, 53 needle hole, for needle sizes 12 and 13, trims back of needle and .025 in. to right of seam |
| 211517 | 12065 | Throat Plate complete, 53 needle hole, for needle sizes 12 and 13, trims back of needle and .025 in. to right of seam, Nos. 207471, 223445 and two 200583u, for 204303, 207651 and 211597 |
| 207300 | 12059 | Throat Plate Knife Cutting Bar, 50 needle hole, for needle sizes 14 and 15, trims back of needle and .025 in. to right of seam |
| 211518 | 12065 | Throat Plate complete, 50 needle hole, for needle sizes 14 and 15, trims back of needle and .025 in. to right of seam, Nos. 207300, 223445 and two 200583u, for 204303, 207651 and 211597 |
| 207472 | 12060 | Throat Plate Knife Cutting Bar, 50 needle hole, for needle sizes 14 and 15, trims back of needle and .035 in. to right of seam |
| 211519 | 12065 | Throat Plate complete, 50 needle hole, for needle sizes 14 and 15, trims back of needle and .035 in. to right of seam, Nos. 207472, 211487 and two 200583u, for 204303, 207651 and 211597 |
| 207473 | 12060 | Throat Plate Knife Cutting Bar, 50 needle hole, for needle sizes 14 and 15, trims back of needle and .050 in. to right of seam |
| 211520 | 12065 | Throat Plate complete, 50 needle hole, for needle sizes 14 and 15, trims back of needle and .050 in. to right of seam, Nos. 207473, 211487 and two 200583u, for 204303, 207651 and 211597 |

KNIFE GRINDER

| No. | Plate | Name |
|---------|-------|--|
| 206977 | ---- | Emery Wheel, 2 in. diameter |
| 206962 | 11296 | " " Driving Shaft |
| 201510D | 11296 | " " " " Nut |
| 204101 | 11296 | " " " " " |
| | | Washer |
| 206963 | 11296 | Emery Wheel Driving Shaft Pulley with two 200403c |
| 200403c | 14103 | Emery Wheel Driving Shaft Pulley Set Screw |
| 244040 | 11296 | Emery Wheel Guard |
| 200054E | 11296 | " " " Screw |
| 206969 | 11296 | " " Washer (paper) |
| 206964 | ---- | Knife Grinder Frame with two 54897 |
| 54897 | 14101 | Knife Grinder Frame Oil Cup |
| 207029 | 11296 | " Holder Slide Bracket with 200394c, 200457D and 201168D ... |
| 200457D | 11296 | Knife Holder Slide Bracket Adjust- ing Screw |
| 206966 | 11296 | Knife Holder Slide Bracket Adjust- ing Screw Slide Plate |
| 200577H | 10473 | Knife Holder Slide Bracket Adjust- ing Screw Slide Plate Screw |
| 200394c | 11296 | Knife Holder Slide Bracket Set Screw |
| 206967 | 11296 | Knife Holder Slide Bracket Shaft |
| 207031 | 11296 | " " " " " |
| | | Collar with 200473B |
| 200473B | 11296 | Knife Holder Slide Bracket Shaft Collar Thumb Screw |
| 201168D | 11296 | Knife Set Screw |
| 207032 | 11296 | Knife Grinder complete, Nos. 200577H, 201510D, 204101, 206962 to 206964, 206966, 206967, 206977, 207029, 207031, 244040, two each 200054E and 206969 |

KNIVES

| No. | Plate | Name |
|--------|-------|-------------|
| 207801 | 10620 | Knife |
| 207802 | 10620 | " |
| 207803 | 10620 | " |
| 207803 | 10620 | " |
| 207804 | 10620 | " |
| 207805 | 10620 | " |
| 207806 | 10620 | " |
| 207807 | 10620 | " |
| 207808 | 10620 | " |

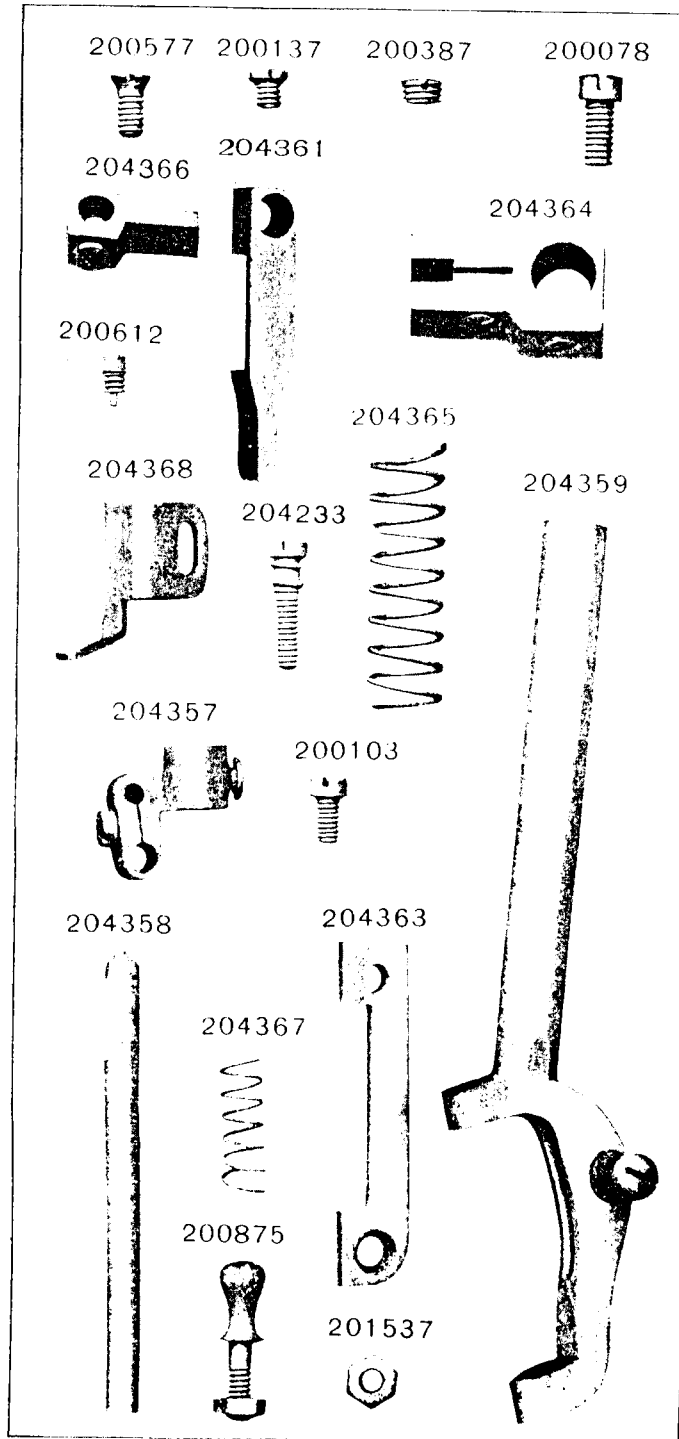
OBSOLETE PARTS

| | | |
|--------|-------|---|
| 202470 | 12320 | Bobbin Winder Base |
| 202471 | 12320 | " " Frame |
| 202472 | 12319 | " " " Spring |
| 202474 | 12320 | " " Spindle |
| 227522 | 12319 | " " Stop Latch |
| 202477 | 12319 | " " " Thumb Lever |
| 202480 | 12320 | Bobbin Winder Spool Holder Base with 200355H and 202484 |
| 202481 | 12320 | Bobbin Winder Spool Holder Base Spool Pin |
| 202482 | 12319 | Bobbin Winder Spool Holder Ten- sion Disc (lower or upper) |
| 202483 | 12319 | Bobbin Winder Spool Holder Ten- sion Disc Spring (brass) |
| 202484 | 12319 | Bobbin Winder Spool Holder Ten- sion Disc Thread Guide |
| 202485 | 12320 | Bobbin Winder Spool Holder com- plete, Nos. 200011D, 202480, 202481, 202483, two 202482 and one wood screw 1 in., No. 13 |

| No. | Plate | Name |
|--------|-------|---|
| 227522 | 12319 | Bobbin Winder Stop Latch |
| 227523 | 12320 | Bobbin Winder complete, Nos. 200056e, 200161b, 200221b, 201537u, 202470 to 202474, 202477, 204278, 227522, three 200299u and two round head wood screws $\frac{3}{4}$ in., No. 12 |
| 213145 | 11281 | Face Plate with 200366u, 200368u, 202087, 202090, 204185 and two 200397u |
| 213653 | 11281 | Face Plate complete, Nos. 200122u, 200319c, 200577u, 202088, 204059, 204272, 204280, 213145, 213164 and 213165 |
| 213148 | 11282 | Feed Driving Eccentric (adjustable) |
| 213149 | 11282 | Feed Driving Eccentric Adjusting Disc |
| 204306 | 14512 | Feed Wheel Driver with 204189, 204307 and 204311 |
| 213867 | --- | Feed Wheel Driver 204306 with 200263e, 201528e and 213866, for Machines Nos. 29w14 and 29w21 |
| 204307 | 11286 | Feed Wheel Driver Clutch |
| 213864 | 11286 | " " " Crank with two 200383c |
| 213865 | 11286 | Feed Wheel Driver Crank Lever (auxiliary) |
| 213866 | ---- | Feed Wheel Driver Crank Lever 213865 with 204310, 213864 and two 200266b |
| 203250 | 11007 | Hook Driving Shaft Collar with two 200393c |
| 227449 | 14108 | Knee Lifter Lifting Lever |
| 213182 | 11059 | Knife Bar Collar with 200078e and two 200387c, for Machines Nos. 29w15, 29w17, 29w21, 29w23 and 29w27 |
| 213185 | 11059 | Knife Bar Collar Extension, for Machines Nos. 29w15, 29w17, 29w21, 29w23 and 29w27 |
| 213183 | 11059 | Knife Bar Handle (switch-in) |
| 213184 | 11059 | " " " Bracket with 200263e and 201528b |
| 213180 | 11059 | Knife Bar Handle Spring |
| 213778 | --- | " " Position Guide 204373 with 213180, 213183, 213184 and two 200577u, for Machines Nos. 29w15, 29w17, 29w21, 29w23 and 29w27 |

| No. | Plate | Name |
|--------|-------|---|
| 213164 | 11052 | Tension Release Lever |
| 213165 | 11052 | " " " Spring |
| 213156 | 11052 | " " Slide with 204269 |
| 204269 | 11292 | " " " Spring, for 213156 |
| 211426 | 12024 | Throat Plate Knife Follower |
| 211448 | 12024 | " " 56 needle hole, for needle sizes 10 and 11, with 200178b, 200587b, 211416 and 211426, trims opposite the needle and .035, .045, .060 and .085 in. to right of seam, for 211255 and 211256, for Machine No. 29w2 |
| 211449 | 12024 | Throat Plate, 53 needle hole, for needle sizes 12 and 13, with 200178b, 200587b, 211416 and 211426, trims opposite the needle and .045, .060 and .085 in. to right of seam, for 211255 and 211256, for Machine No. 29w2 |
| 211450 | 12024 | Throat Plate, 50 needle hole, for needle sizes 14 and 15, with 200178b, 200587b, 211416 and 211426, trims opposite the needle and .060 and .085 in. to right of seam, for Machine No. 29w2 |
| 211421 | 12064 | Throat Plate, 56 needle hole, for needle sizes 10 and 11, with 200178b, 200587b, 211416 and 211426, trims opposite the needle and .035, .045, .060 and .085 in. to right of seam, for 211255 and 211256, for Machine No. 29w6 |
| 211481 | 12064 | Throat Plate, 53 needle hole, for needle sizes 12 and 13, with 200178b, 200587b, 211416 and 211426, trims opposite the needle and .045, .060 and .085 in. to right of seam, for 211255 and 211256, for Machine No. 29w6 |
| 211482 | 12064 | Throat Plate, 50 needle hole, for needle sizes 14 and 15, with 200178b, 200587b, 211416 and 211426, trims opposite the needle and .060 and .085 in. to right of seam, for 211255 and 211256, for Machine No. 29w6 |

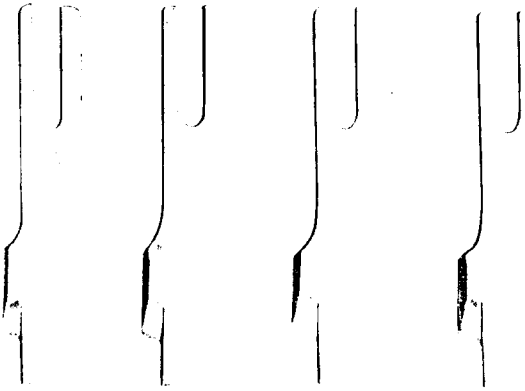
PLATE 10473—FULL SIZE



From the library of: Diamond Needle Corp

PLATE 10620—FULL SIZE

207801 207802 207803 207804



207805 207806 207807 207808

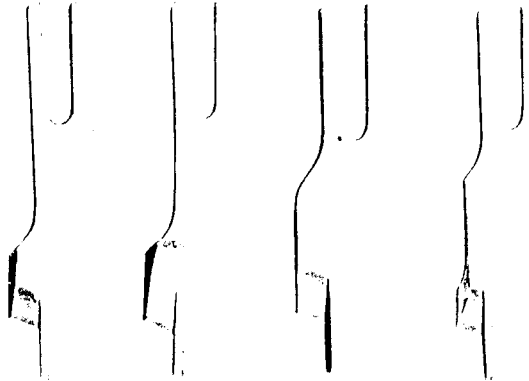
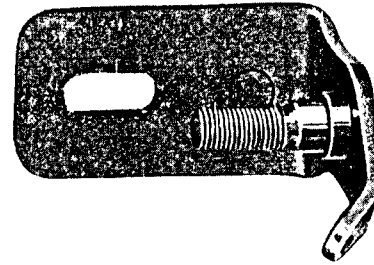


PLATE 10881—FULL SIZE

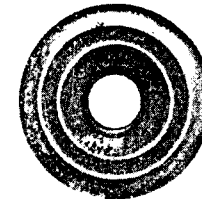
225461



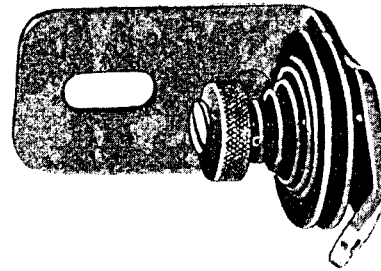
200082 202104



2102



225462



202407



201499



201572



From the library of: Diamond Needle Corp

PLATE 10884—FULL SIZE

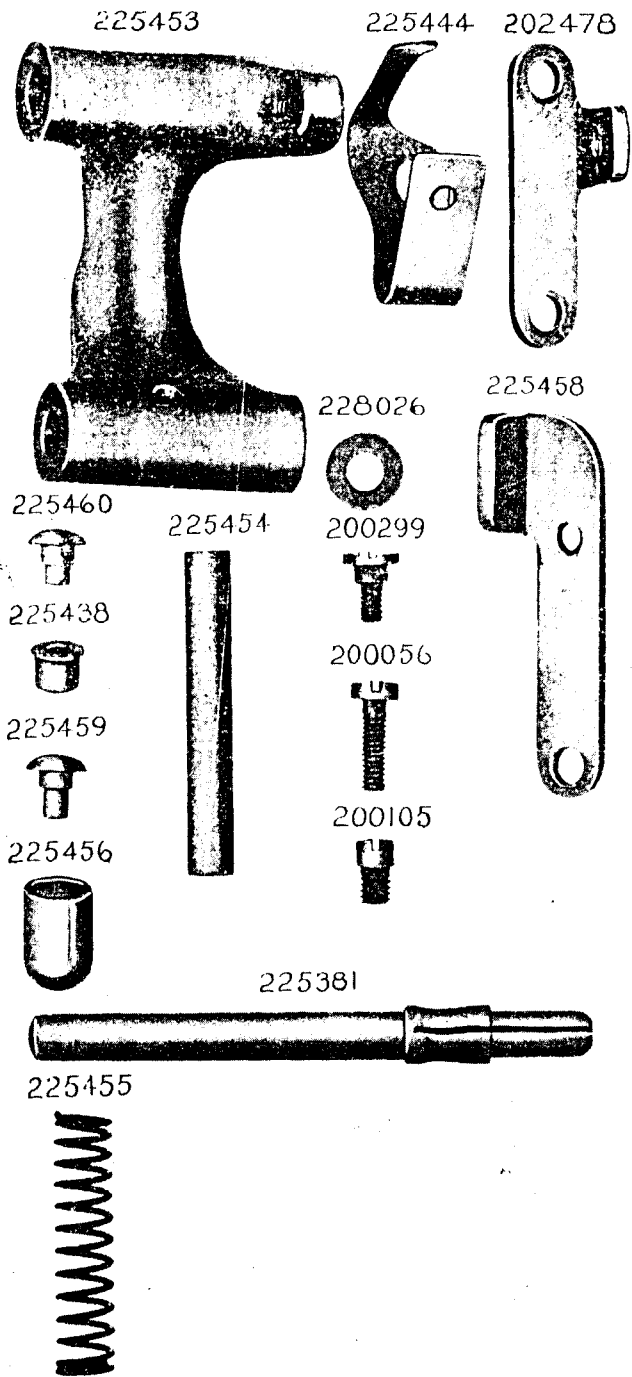
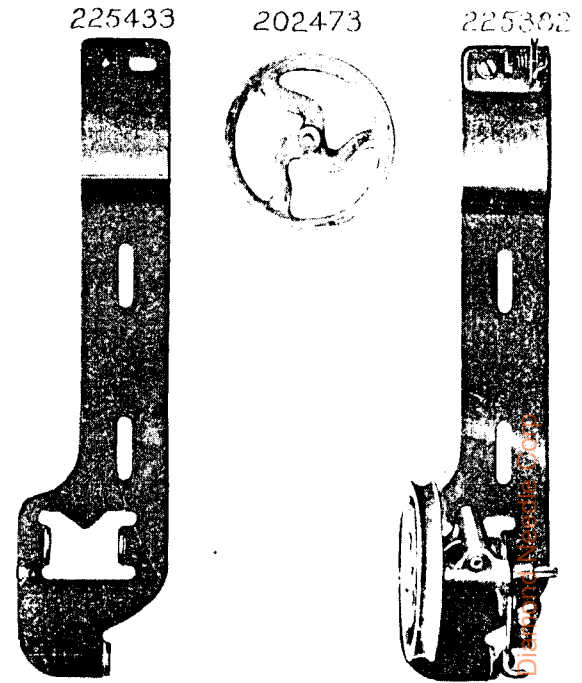


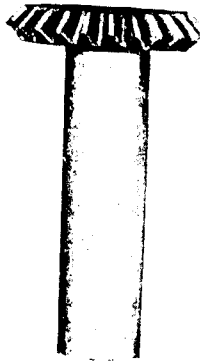
PLATE 10885—ONE-FOURTH SIZE



From the library of: <http://www.gutenberg.org>

PLATE 11007—FULL SIZE

203241



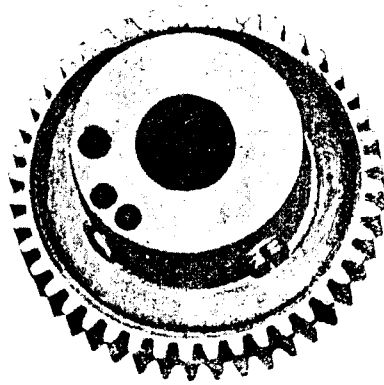
200555



203242



203245



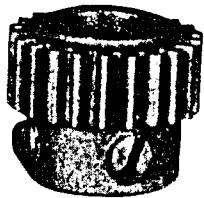
203250



200393

ES

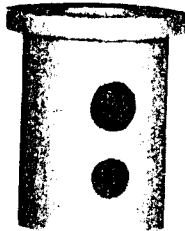
203246



200006



203249



225585



203244



200840

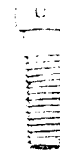


PLATE 11048—FULL SIZE

200338



200038



200545



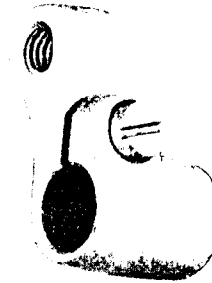
200641



213654



202298



200244



200245



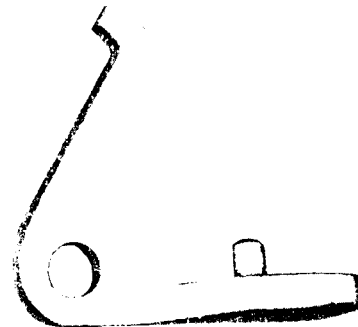
200665



213655



213161



From the library of:  Diamond Drill Corp

PLATE 11052—FULL SIZE

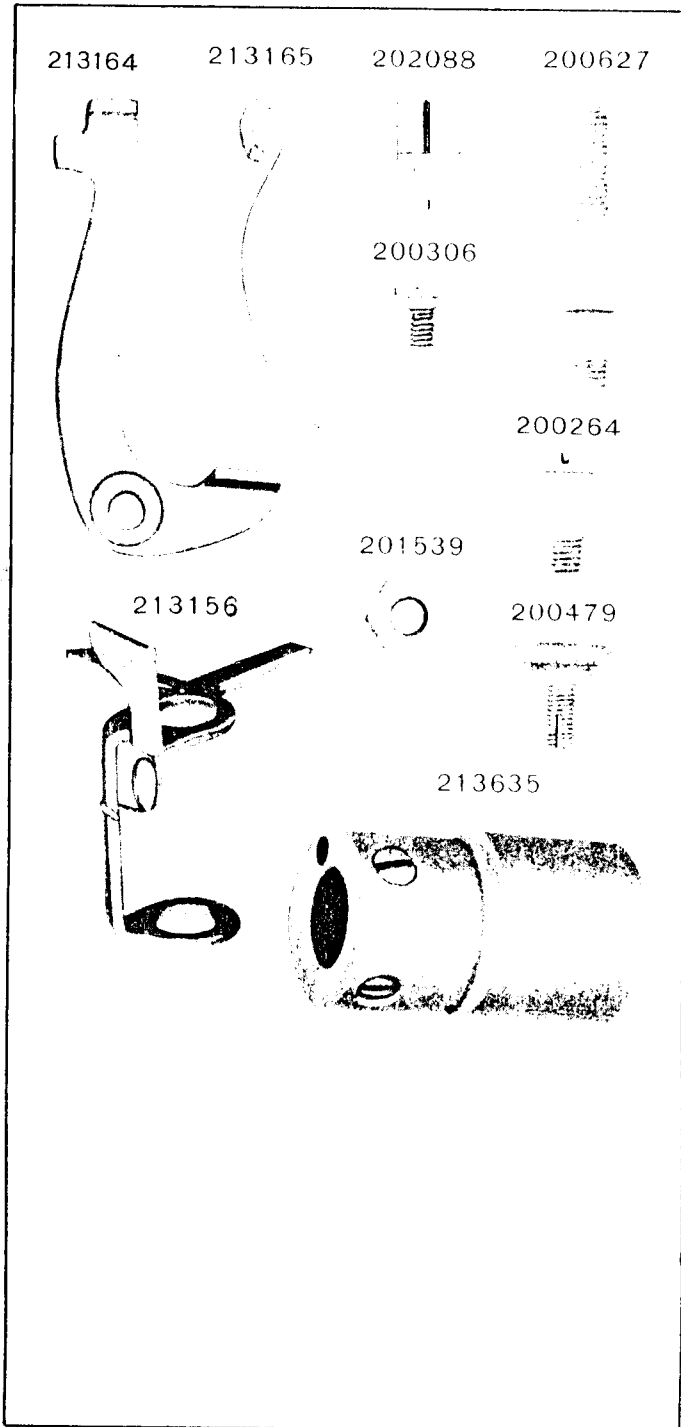
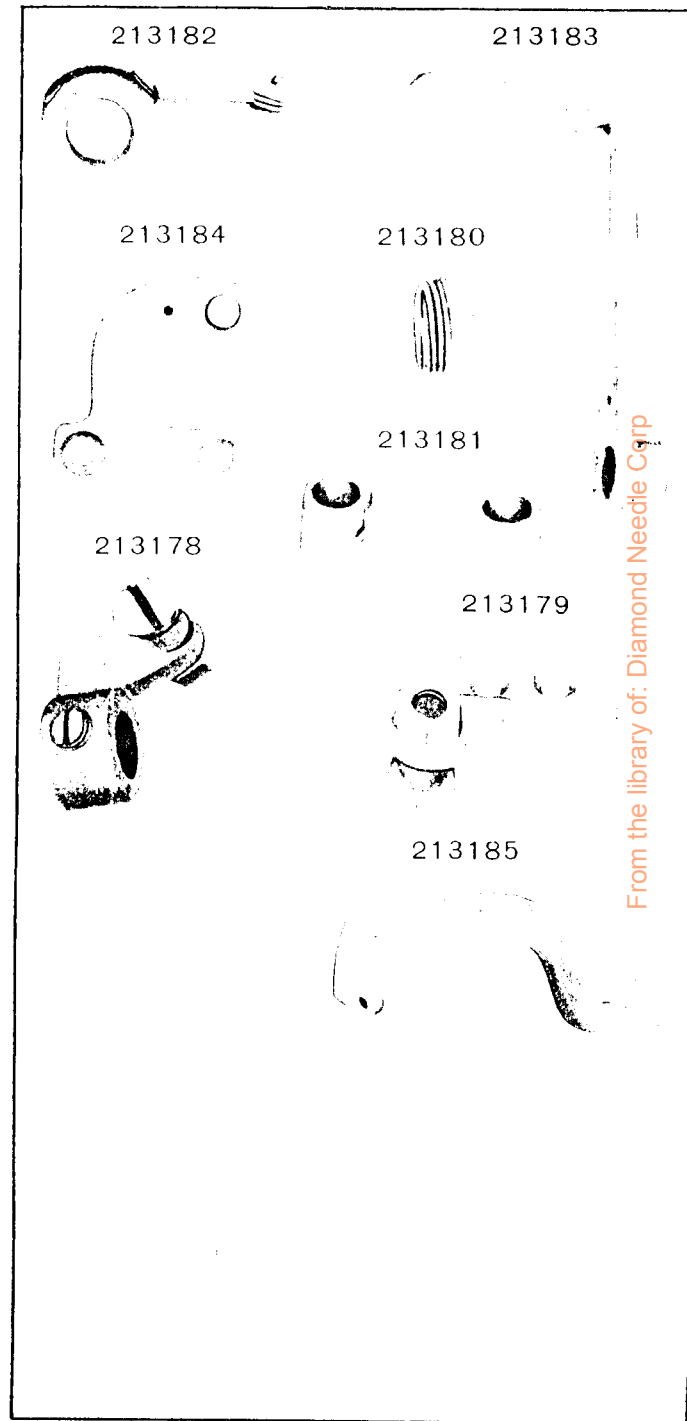


PLATE 11059—FULL SIZE



From the library of: Diamond Needle Corp

PLATE 11241—FULL SIZE

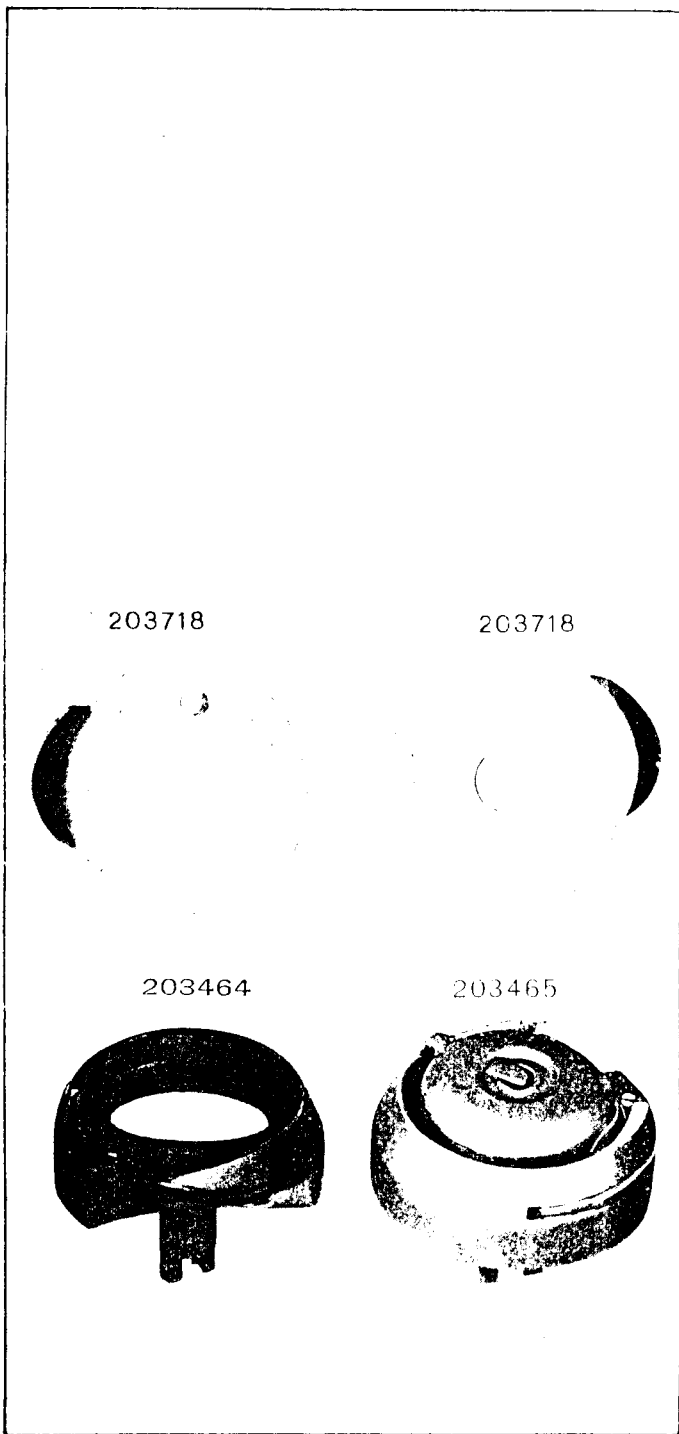


PLATE 11281—ONE-FOURTH SIZE

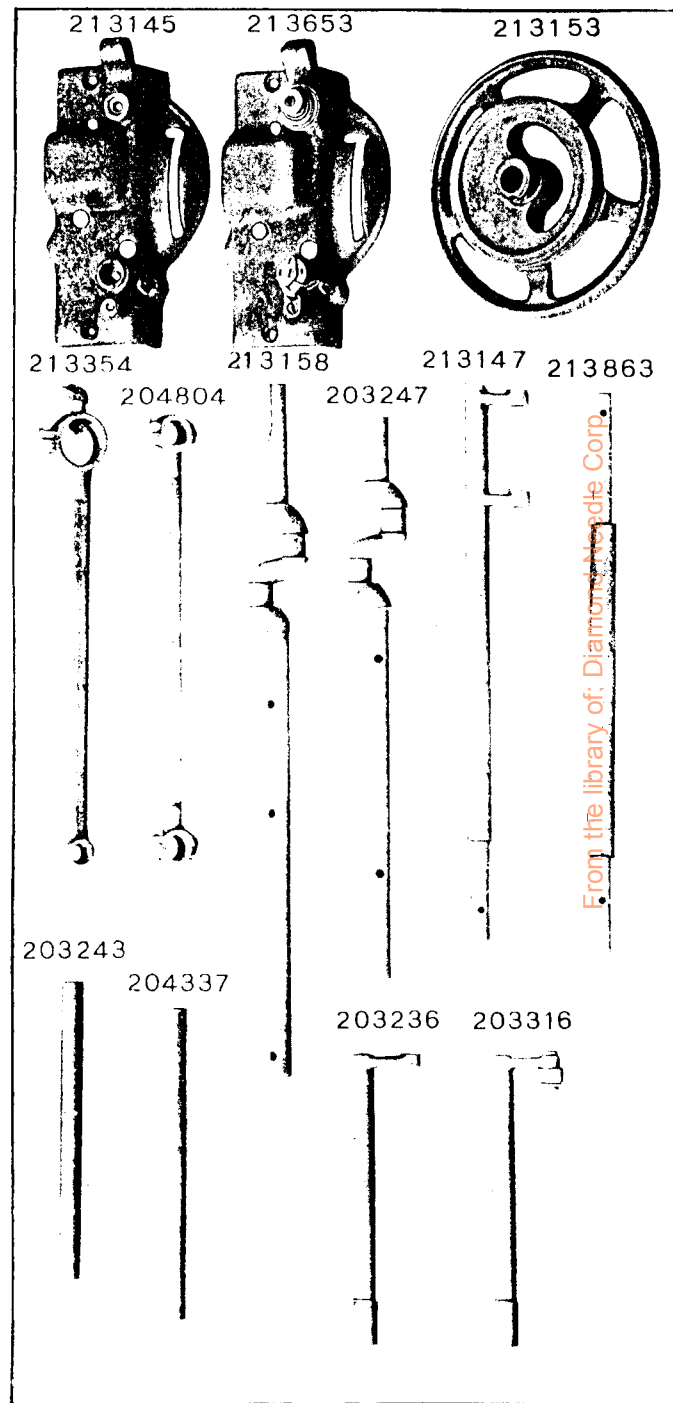


PLATE 11282-ONE-HALF SIZE

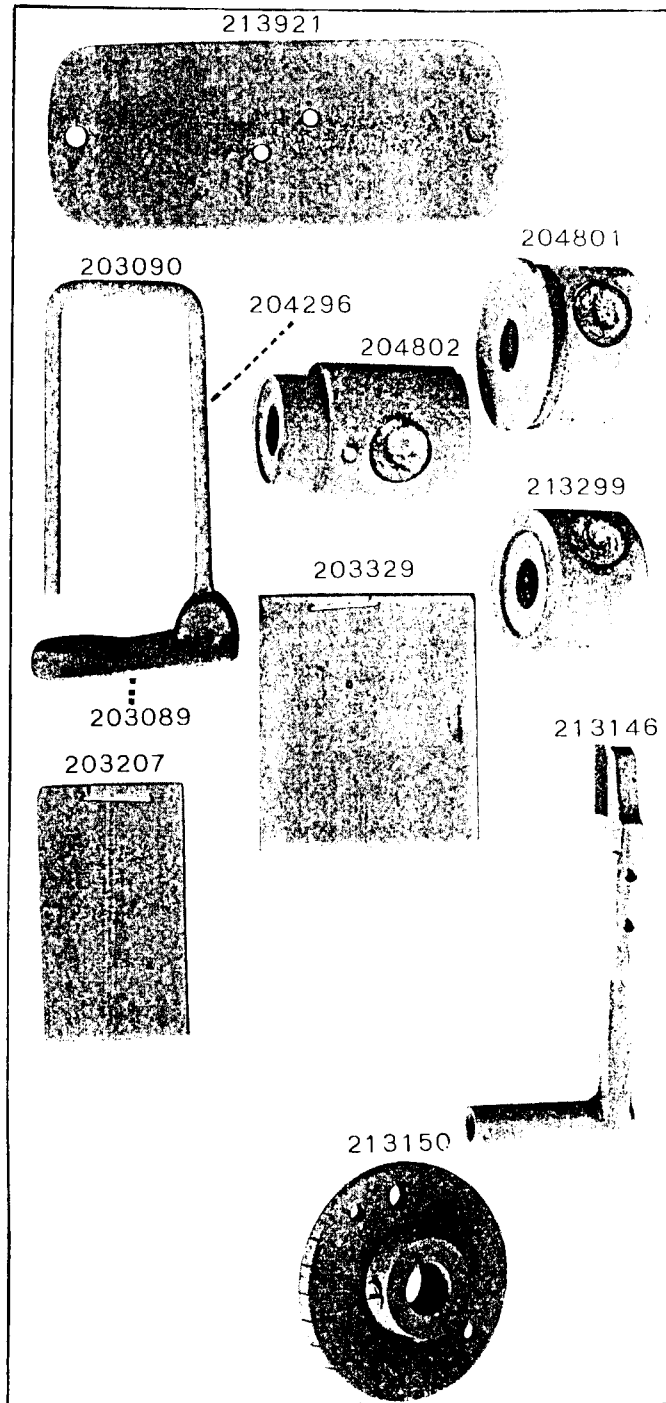
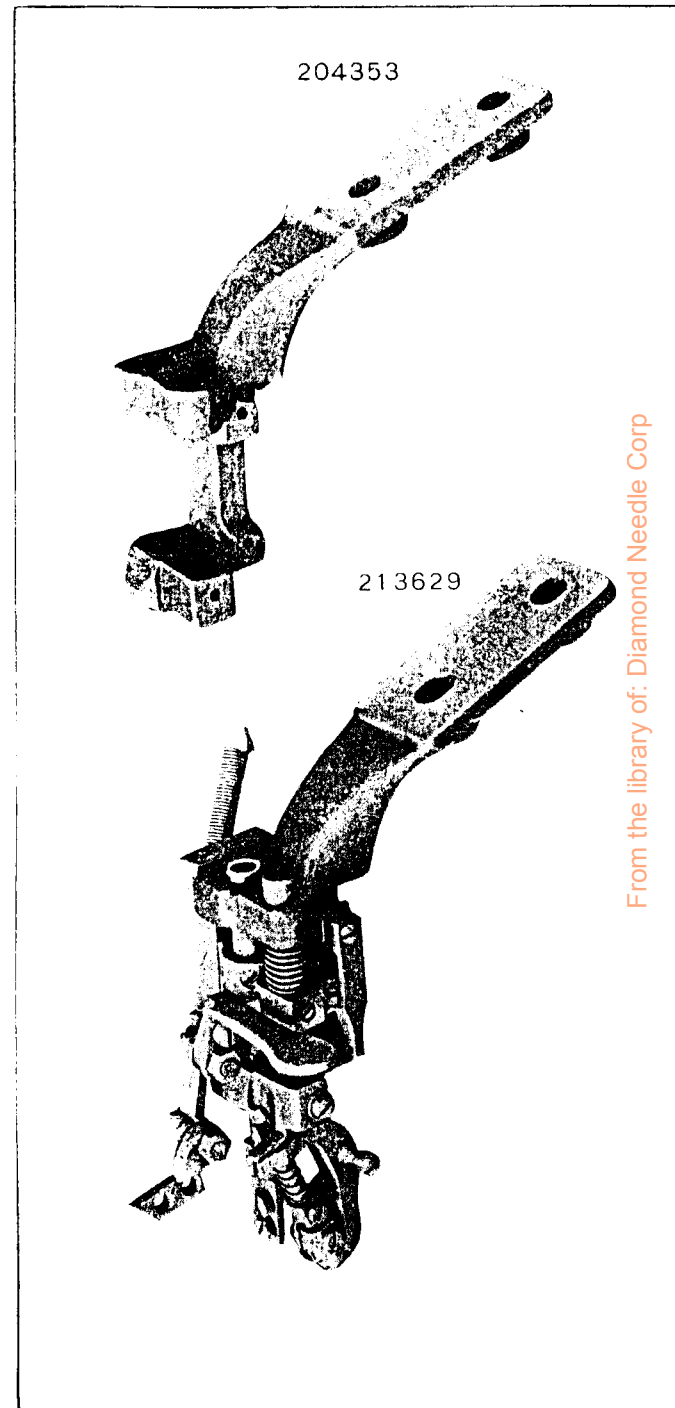


PLATE 11283-ONE-HALF SIZE



From the library of: Diamond Needle Corp

PLATE 11284 - FULL SIZE

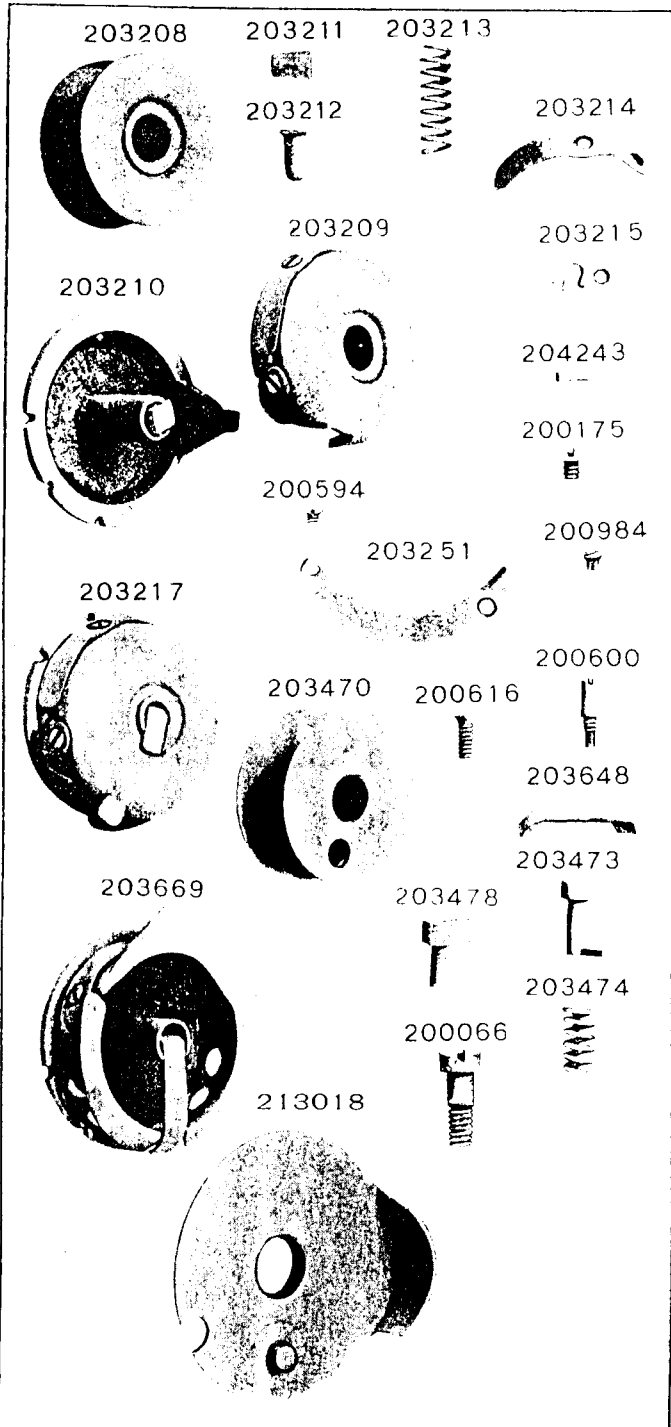
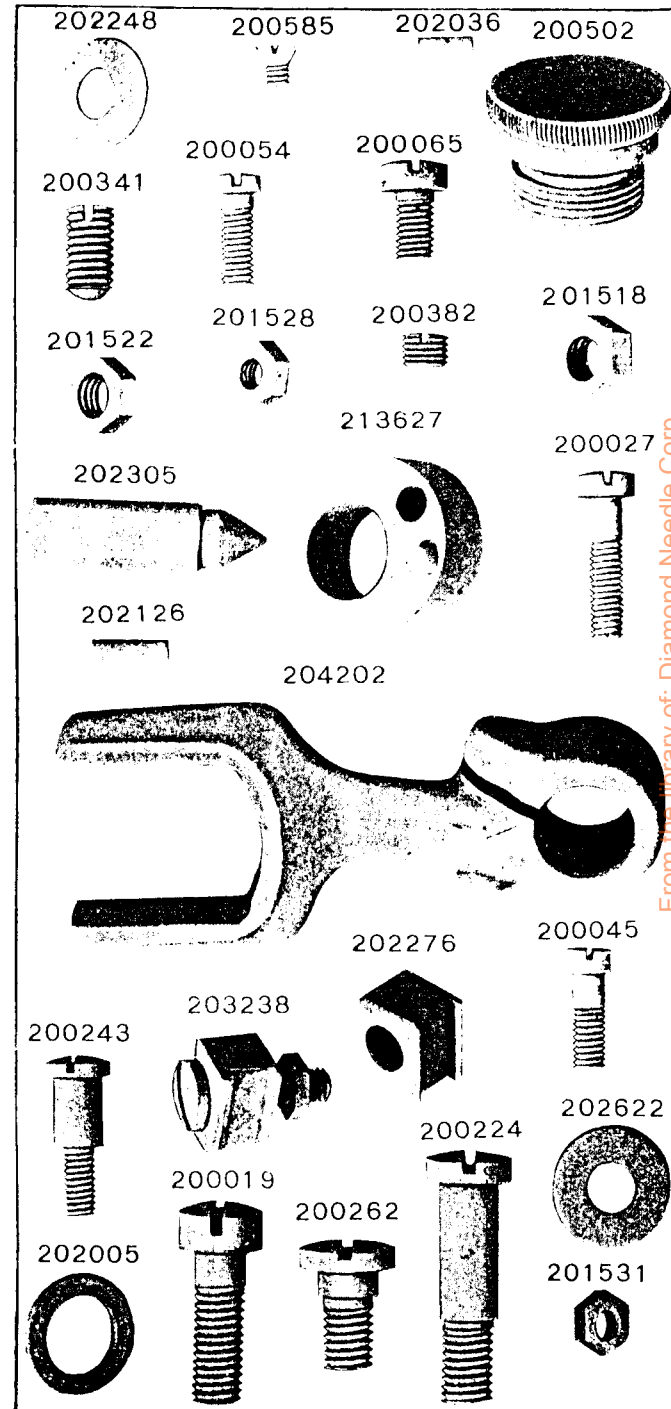


PLATE 11285 - FULL SIZE



From the library of: Diamond Needle Corp

PLATE 11286 - FULL SIZE

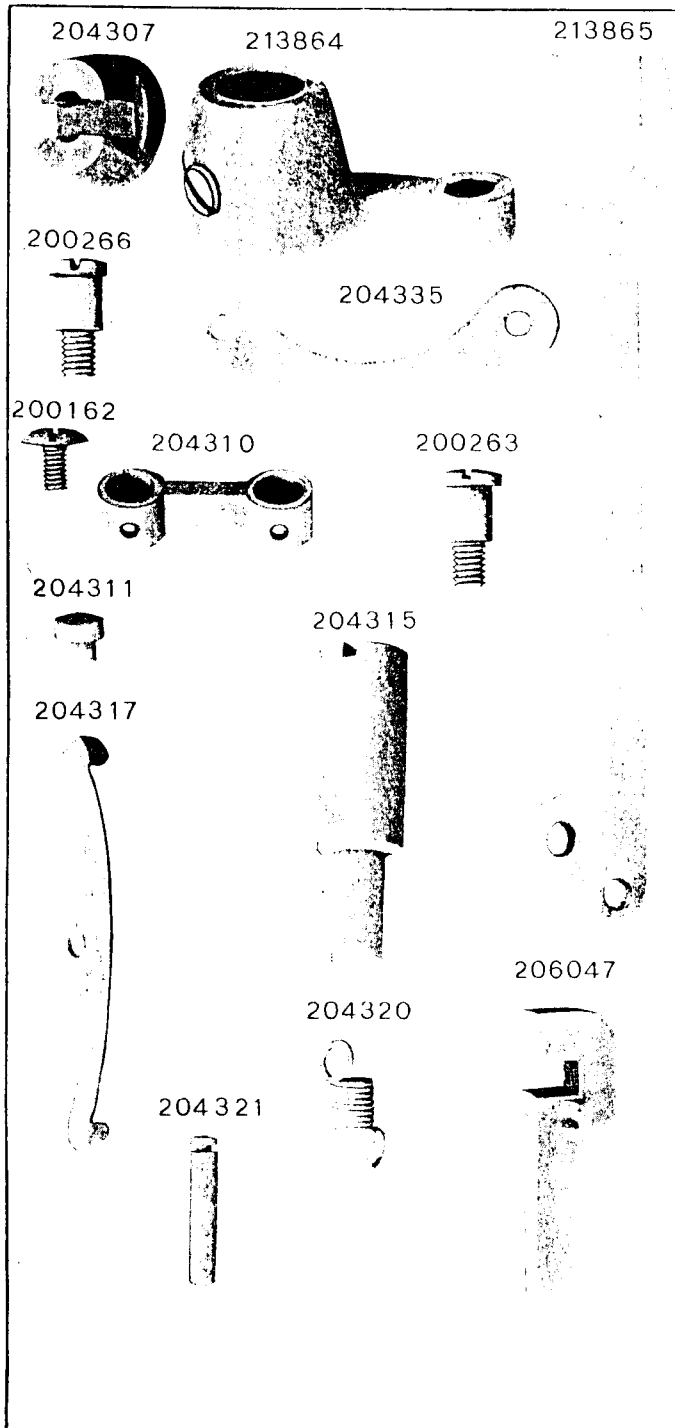
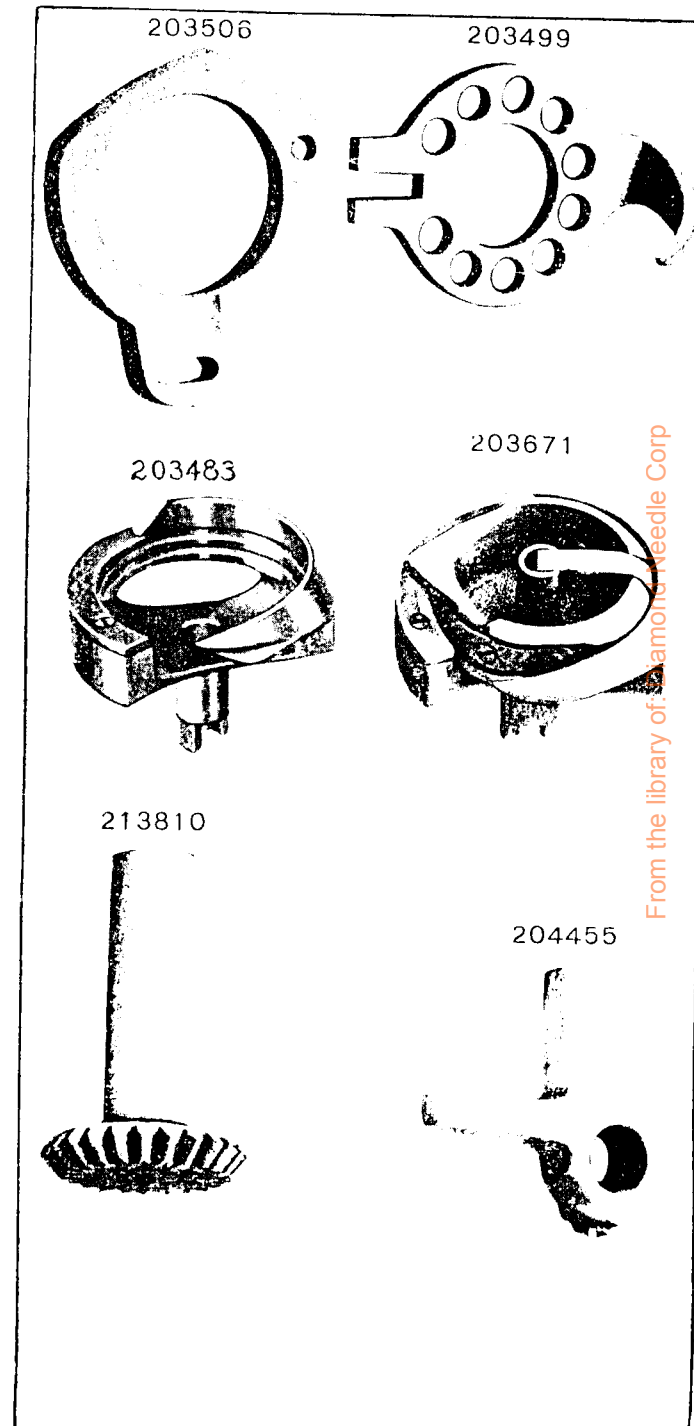


PLATE 11287 - FULL SIZE



From the library of: Sarnonia Needle Corp

PLATE 11288—ONE-HALF SIZE

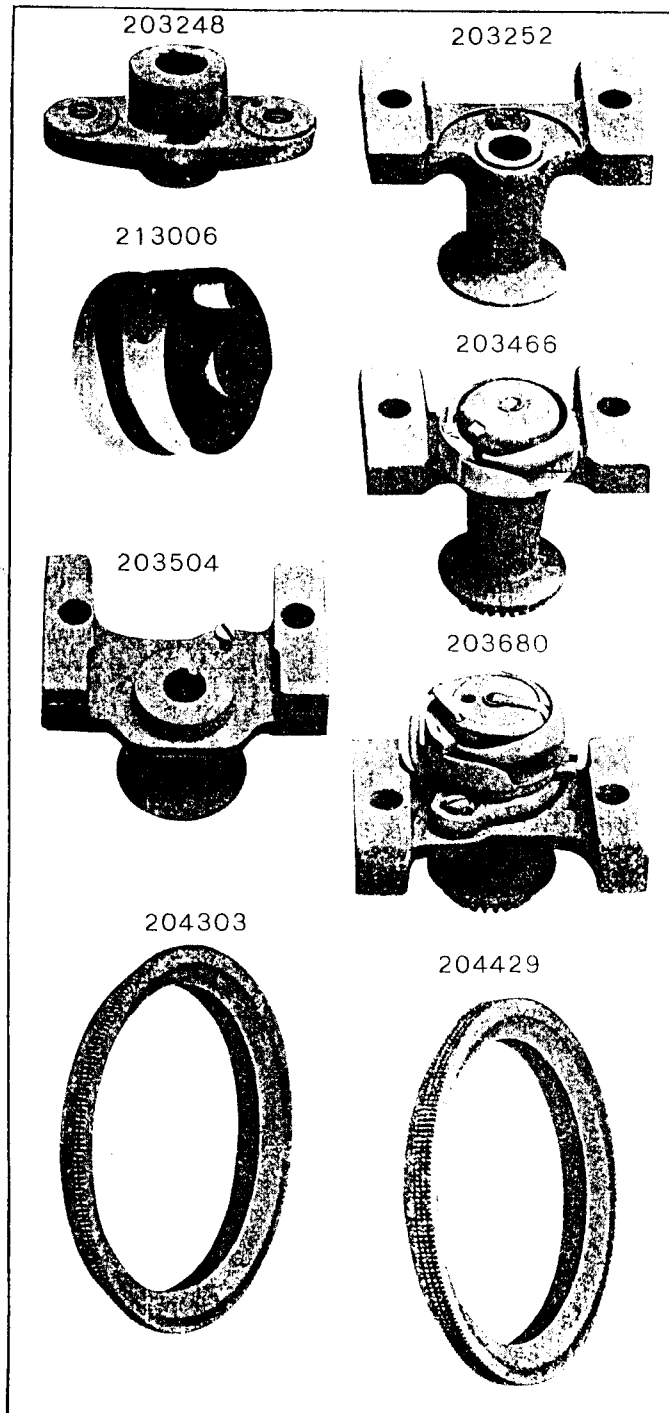


PLATE 11289—ONE-HALF SIZE

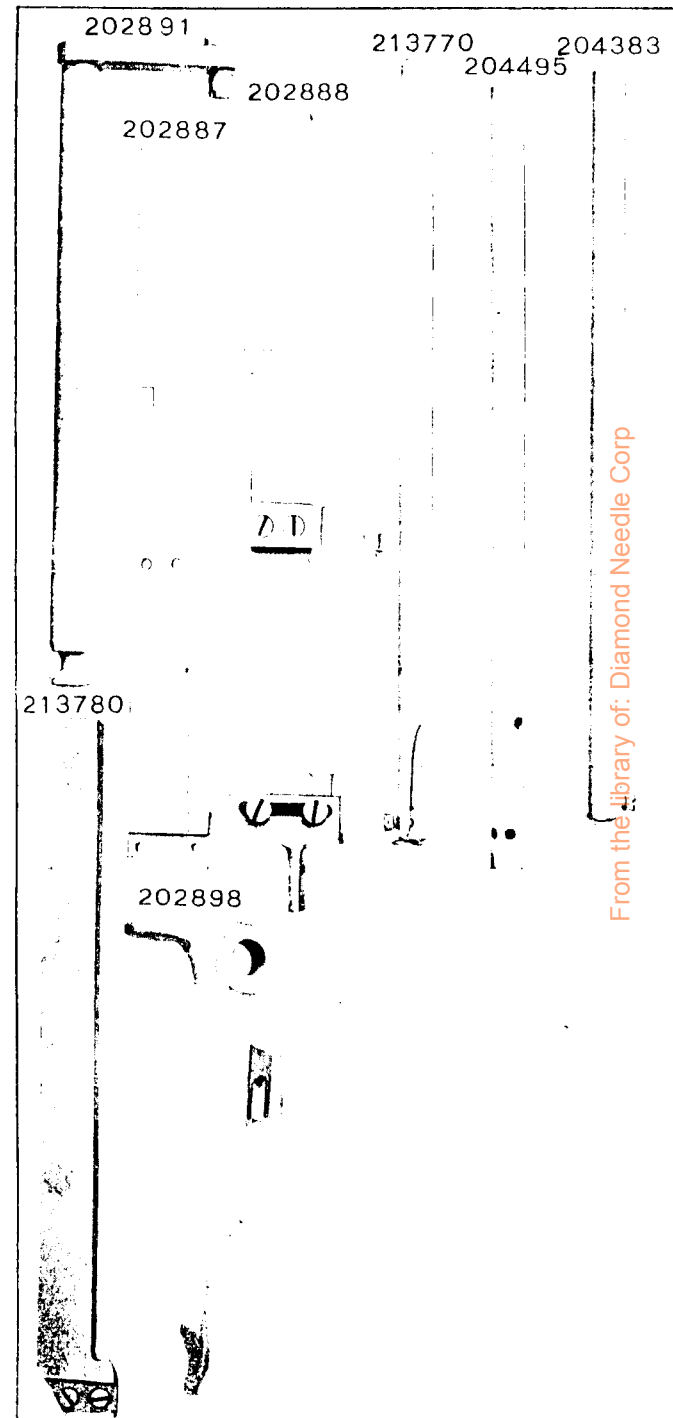


PLATE 11290 - FULL SIZE

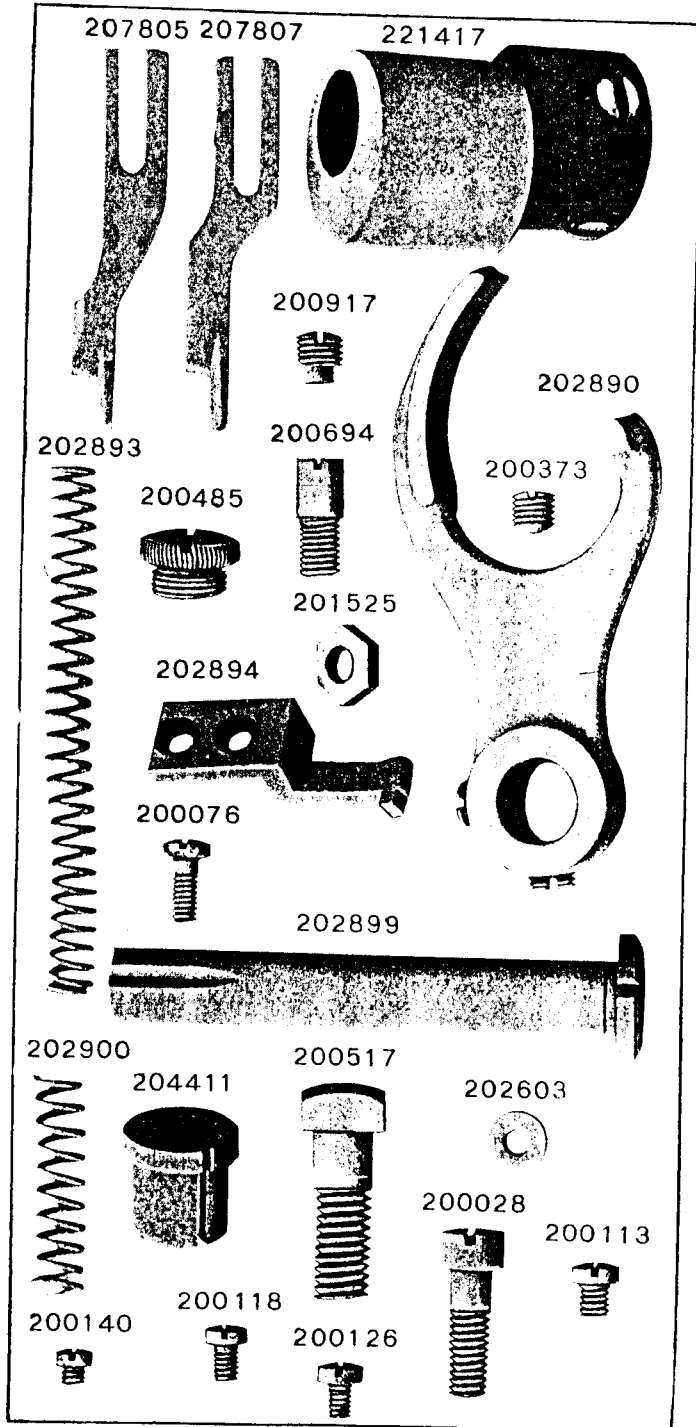
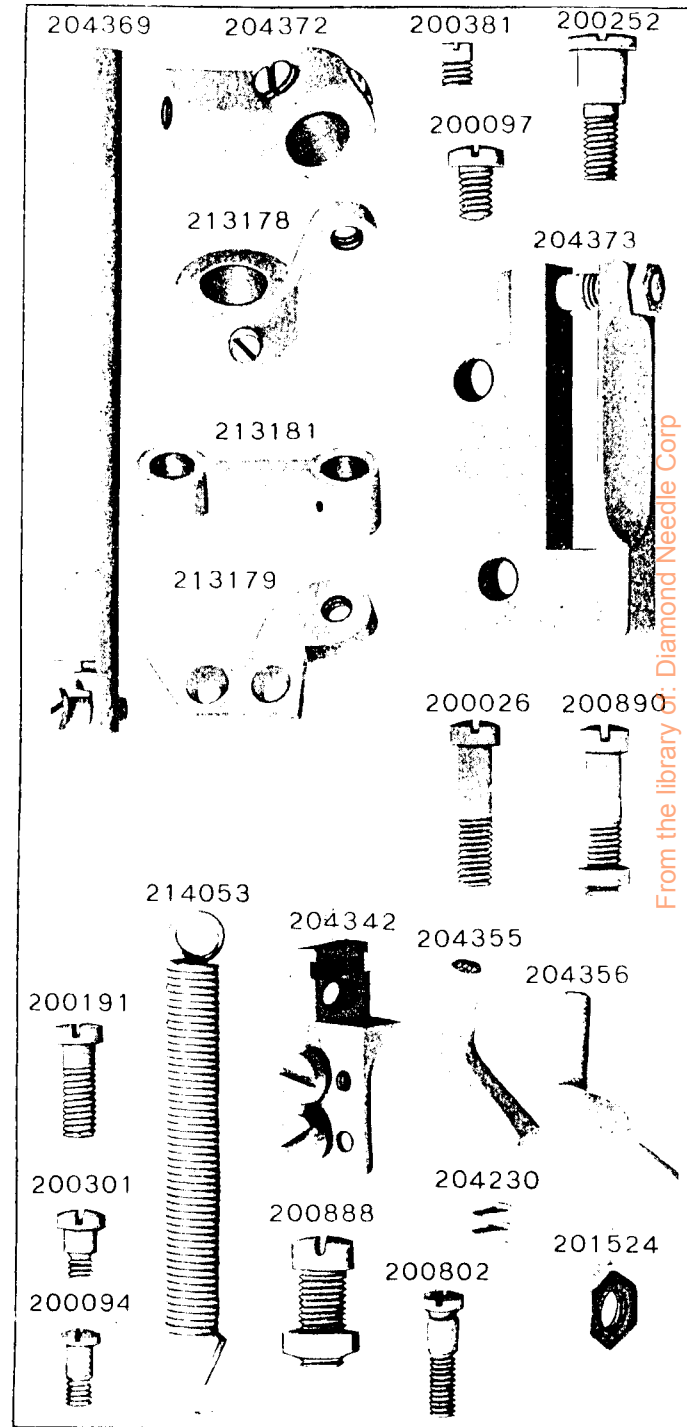


PLATE 11291 - FULL SIZE



From the library of: Diamond Needle Corp

PLATE 11292-FULL SIZE

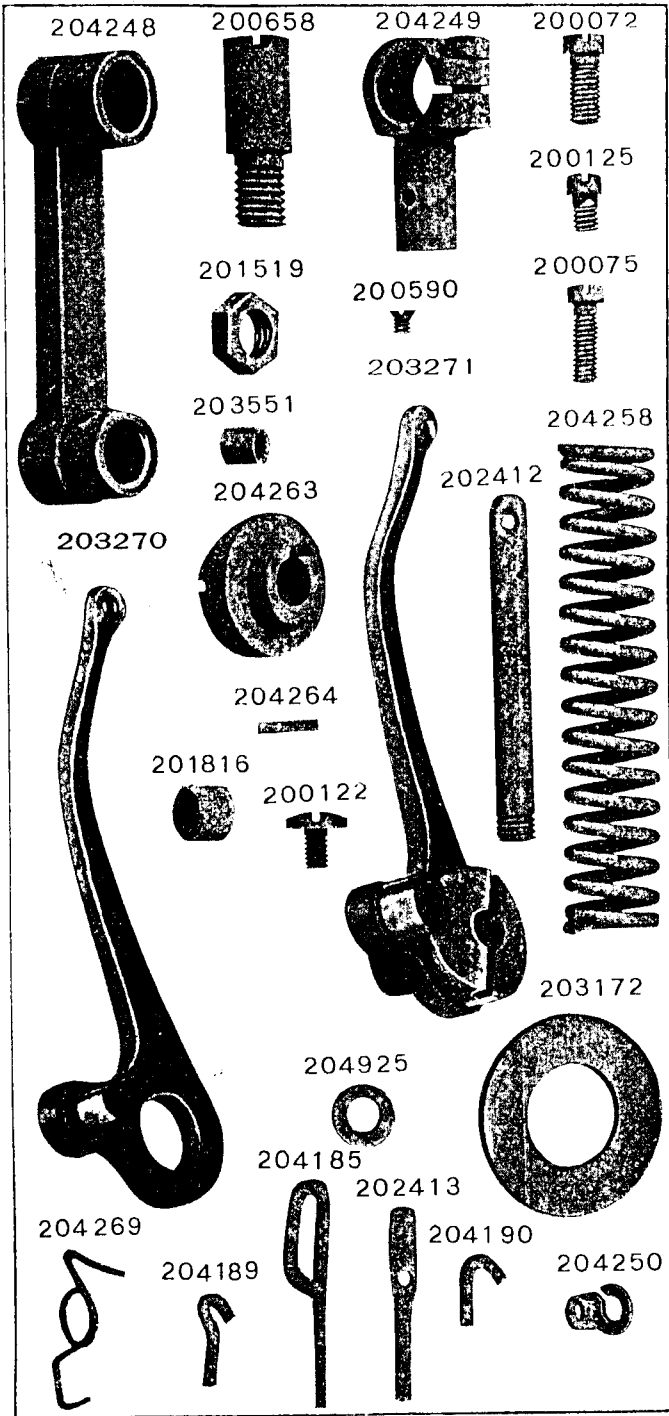
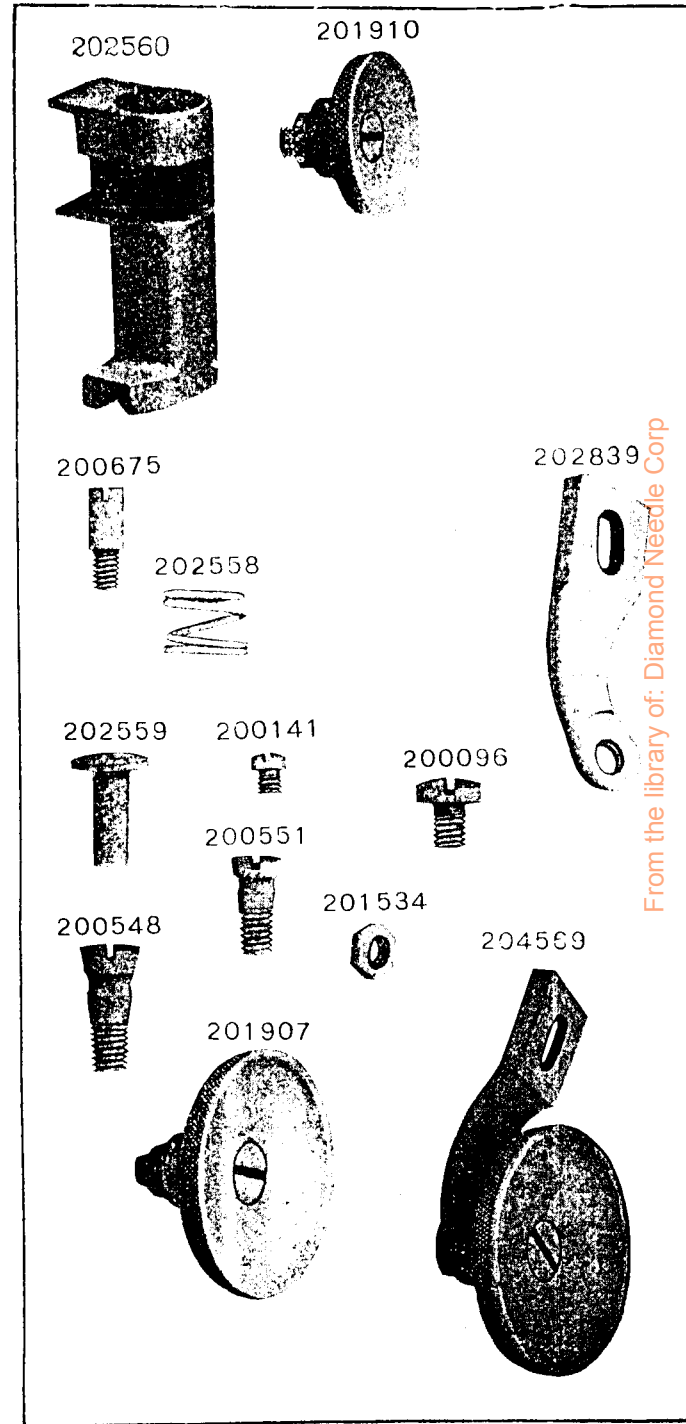


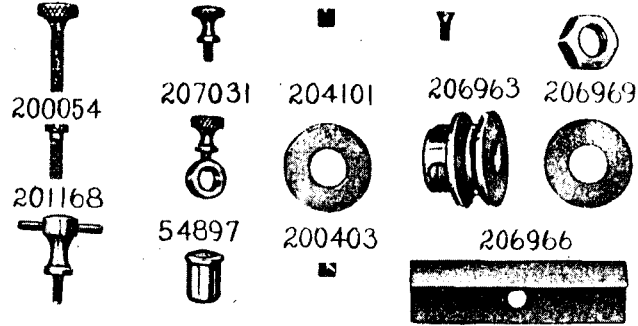
PLATE 11293-FULL SIZE



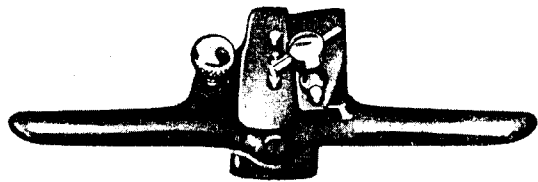
From the library of: Diamond Needle Corp

PLATE 11296—ONE-HALF SIZE

200457 200473 200394 200577 201510



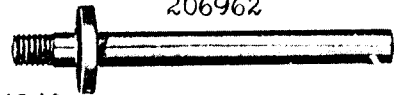
207029



206967



206962



244040



207032

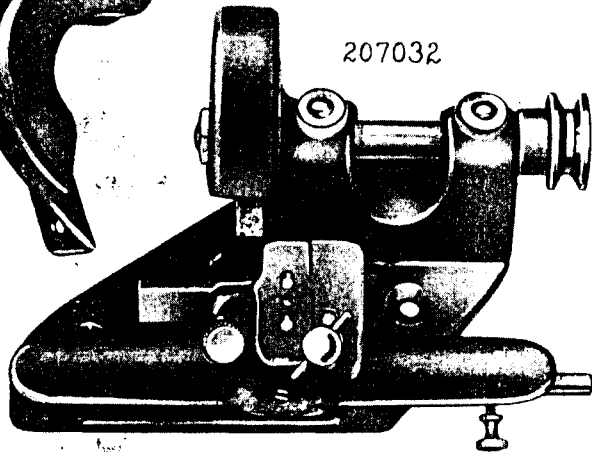
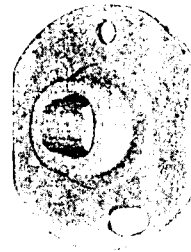
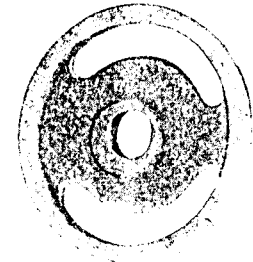


PLATE 11298—ONE-HALF SIZE

223429



223430



From the library of: Diamond Needle Corp

PLATE 11299 - FULL SIZE

223432



223433

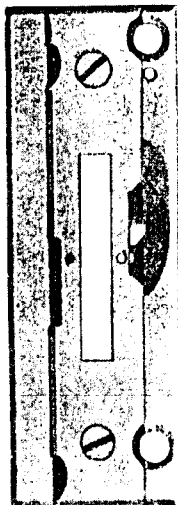
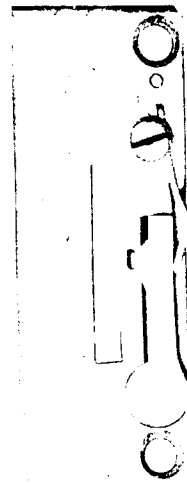


PLATE 12024 - FULL SIZE

211447
211448
211449
211450



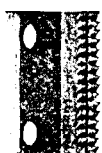
207651



211255



211256



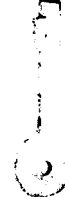
211245
211250
211284
211287
211288



211597



211540



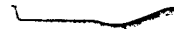
211424



211426



211416



211447
211448
211449
211450



211245
211260
211284
211287
211288



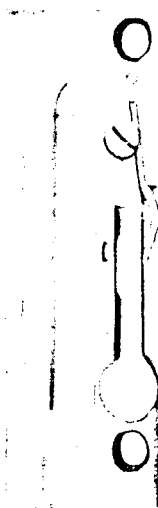
From the Library of: Diamond Needle Corp

PLATE 12058—FULL SIZE

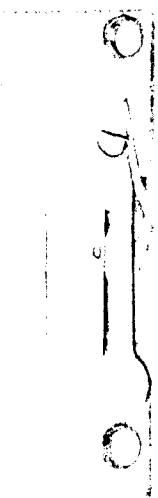
211292
211451
211452
211453
211454



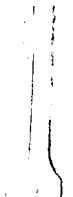
211459
211460
211461
211462



211455
211456
211457
211458



211425



211463
211464

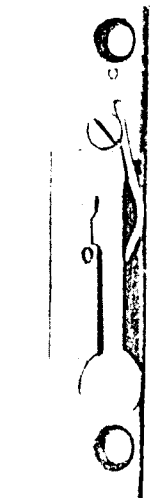
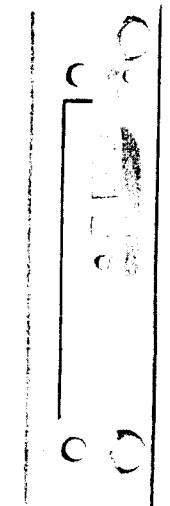
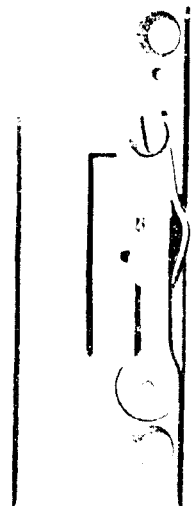
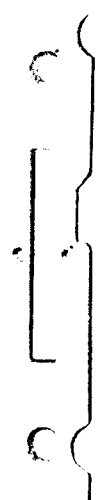
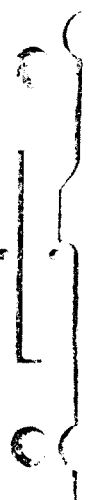


PLATE 12059—FULL SIZE

211465
211466
211467
211468



207464
207299
207471
207300



From the library of: Diamond Needle Corp

PLATE 12060—FULL SIZE

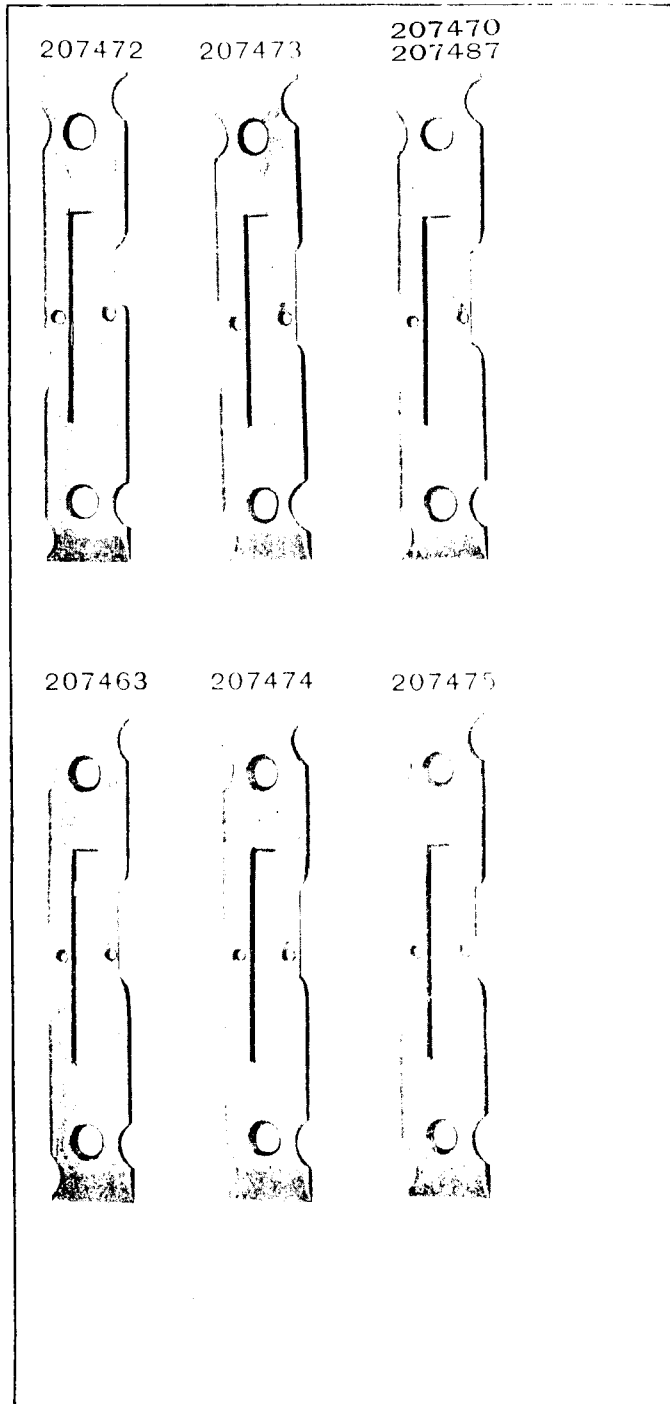


PLATE 12061—FULL SIZE

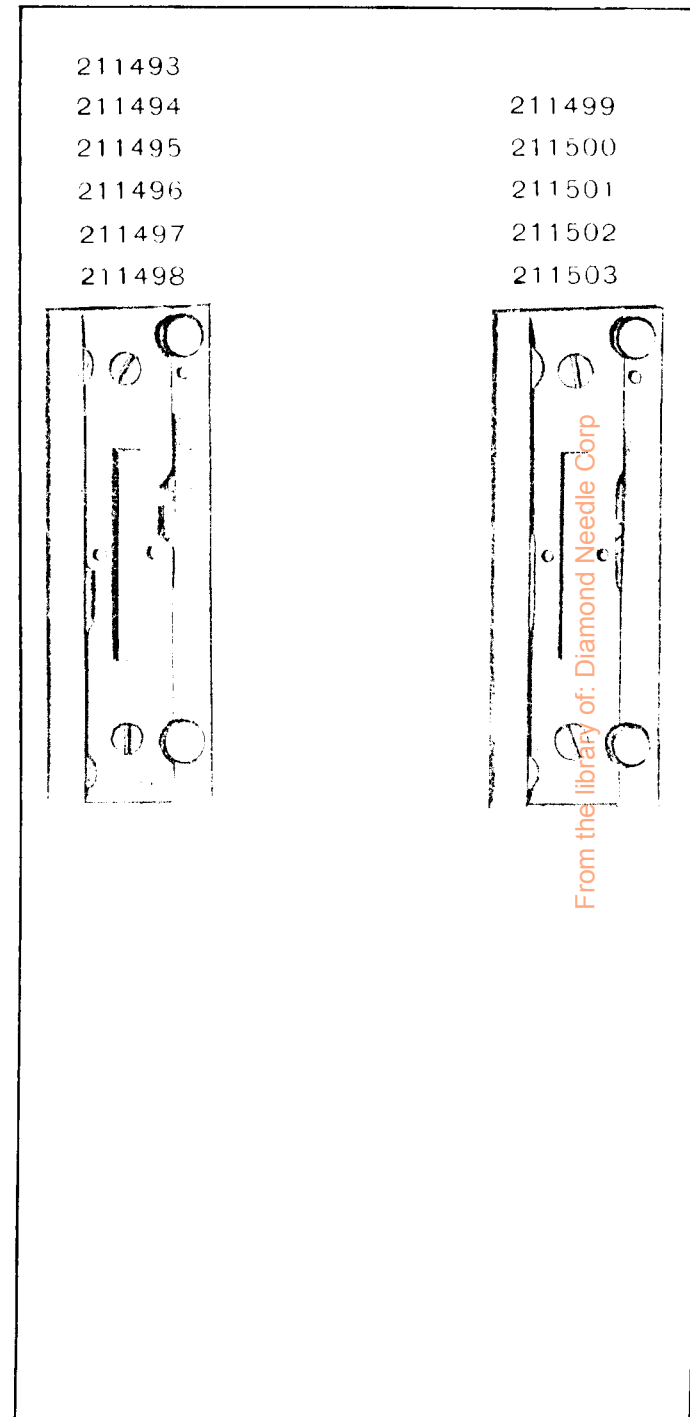
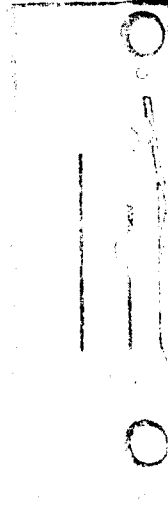
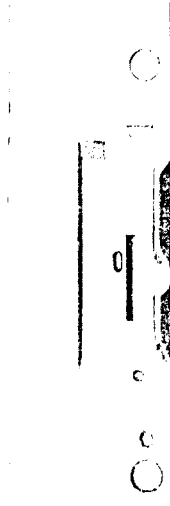
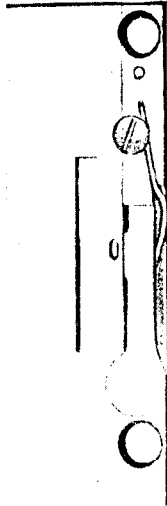


PLATE 12064—FULL SIZE

211421
211481
211482

211421
211481
211482

211420
211422
211483
211484
211605



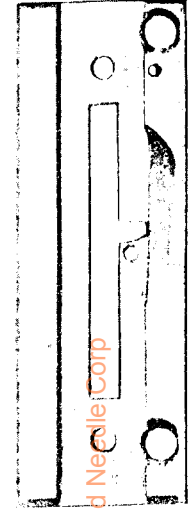
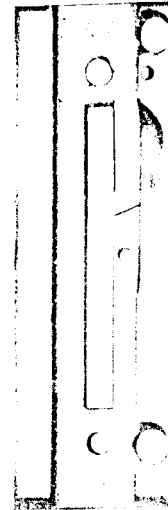
211285
211286
211485
211486
211973



PLATE 12065—FULL SIZE

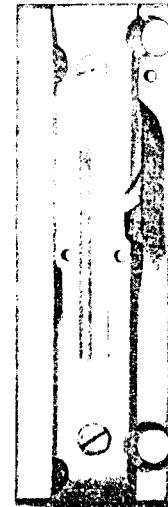
211487

211488



211515
211516
211517
211518
211519
211520

211521
211522
211523
211524
211525



From the Henry J. Diamond Needle Corp

PLATE 12066—FULL SIZE

211489

211491

211490

211492

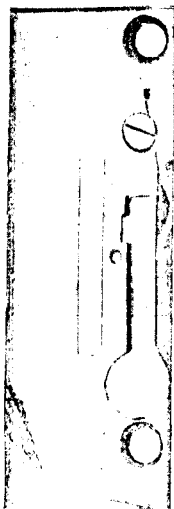


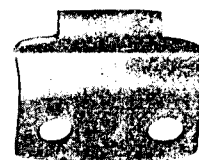
PLATE 12153—ONE HALF SIZE

41400

225498

225497

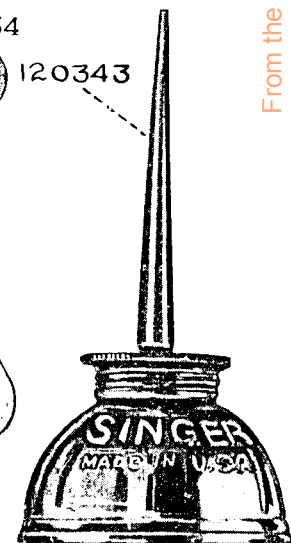
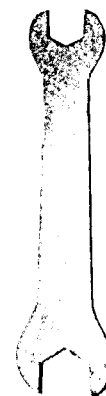
202258



120342

225554

120343



From the library of: Diamond Needle Corp

PLATE 12311—FULL SIZE

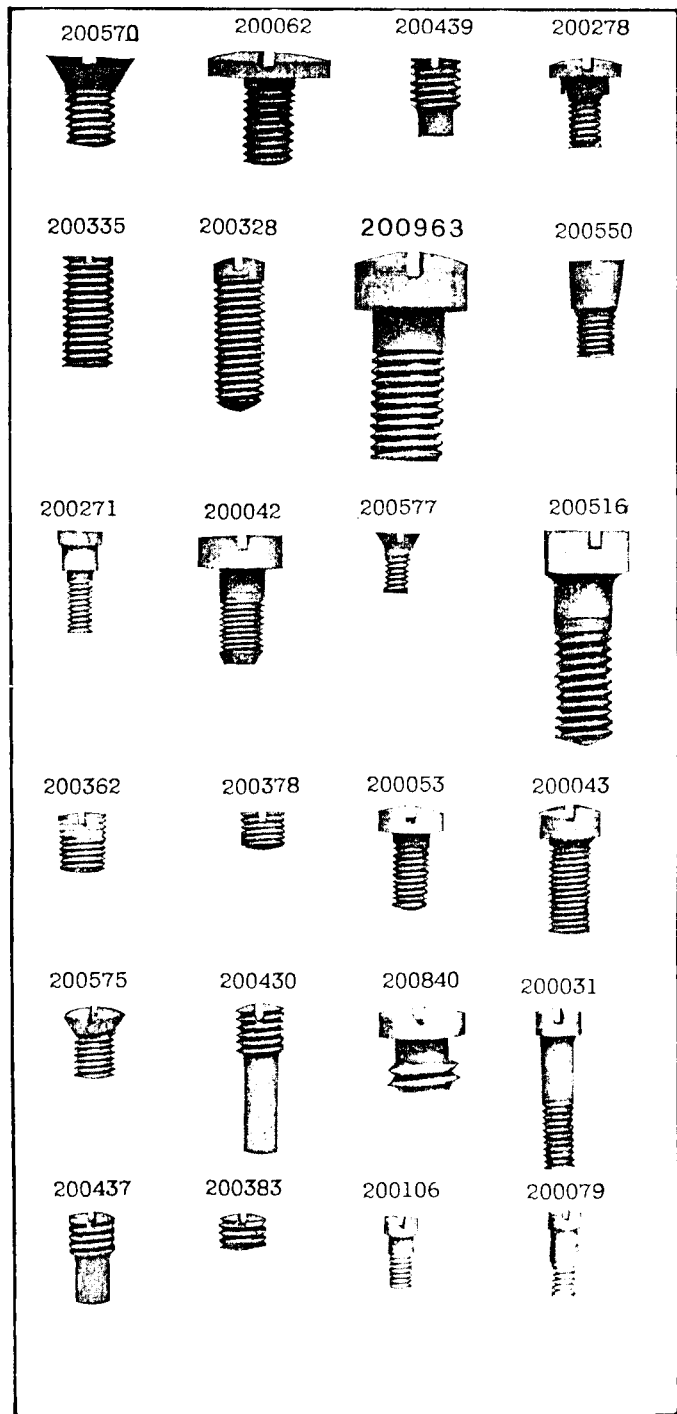
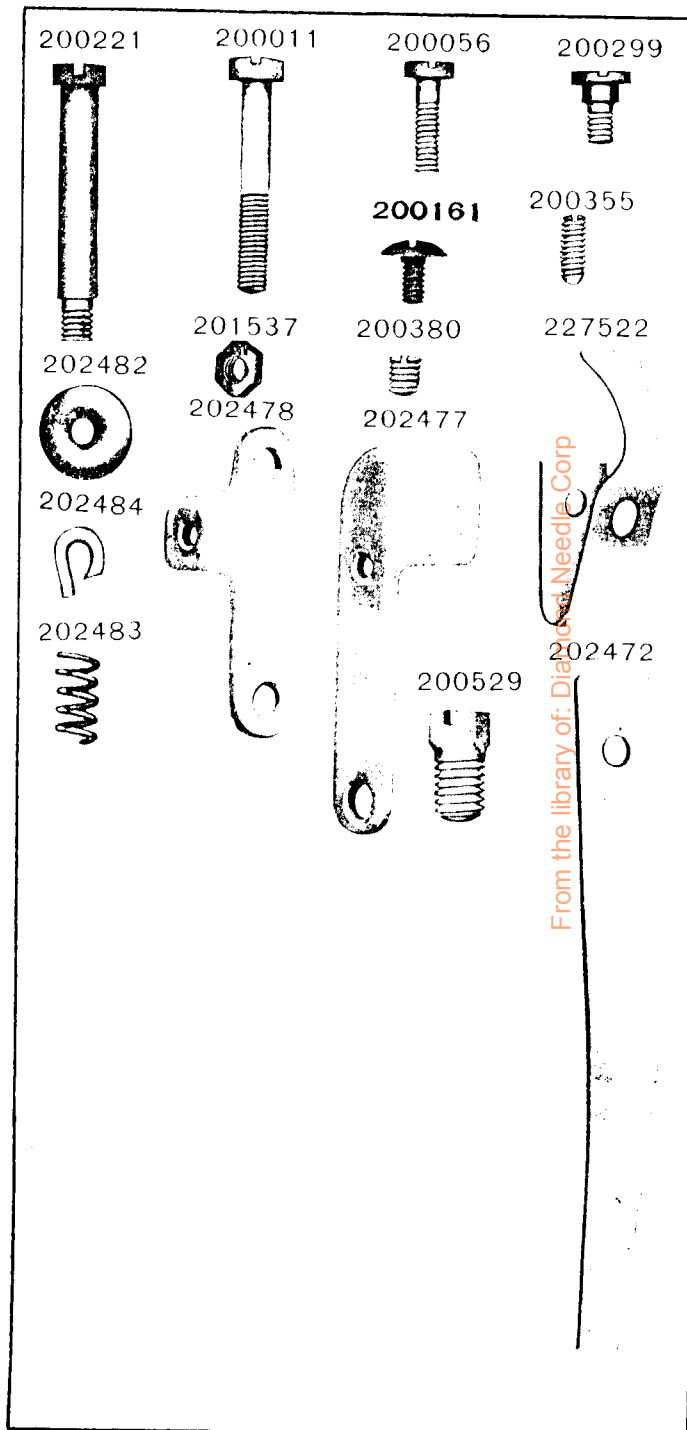


PLATE 12319—FULL SIZE



From the library of: Dial Piston Needle Corp

PLATE 12320—ONE-HALF SIZE

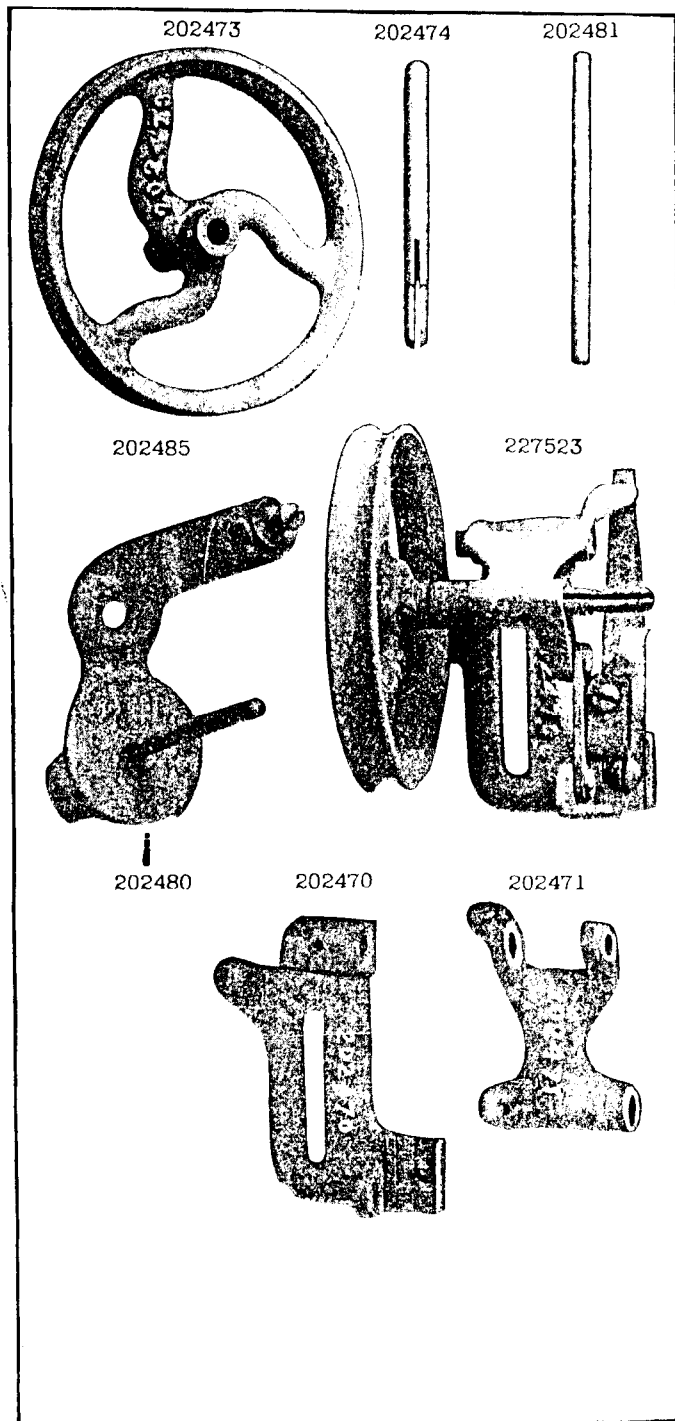


PLATE 12349—FULL SIZE

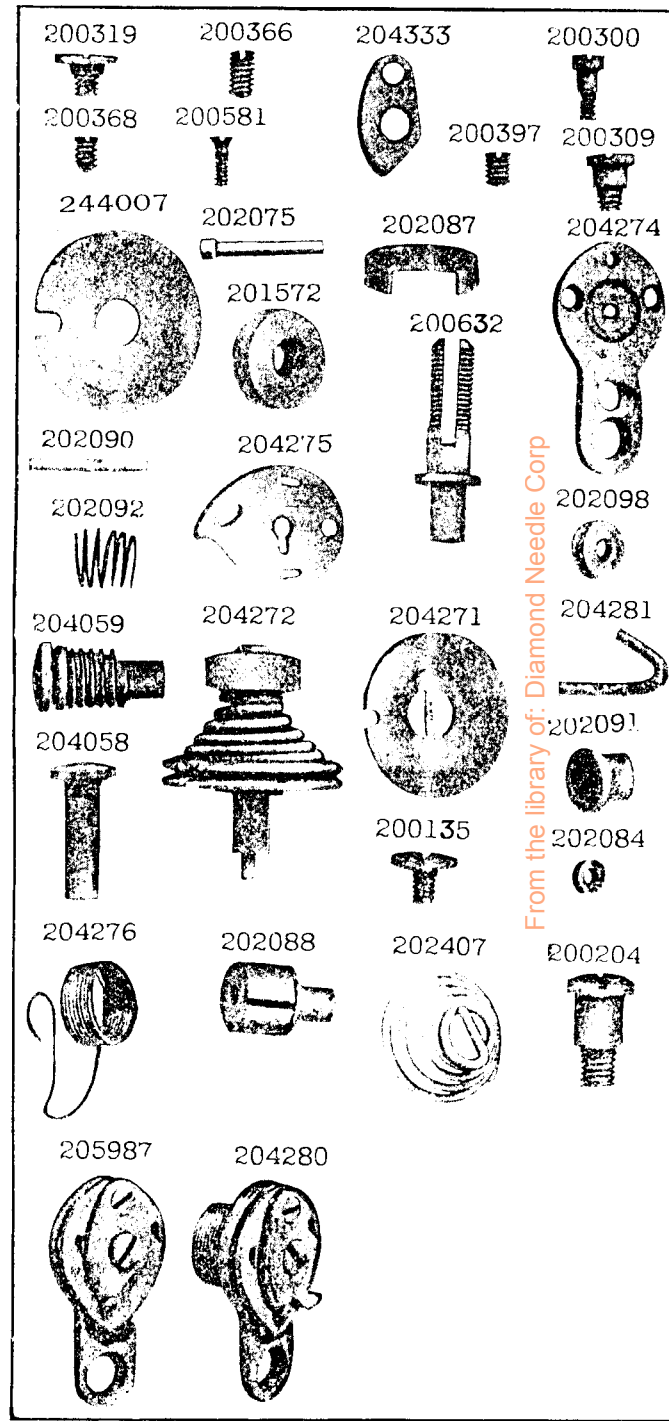


PLATE 14101—FULL SIZE

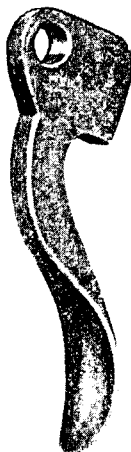
54897



202446



202554



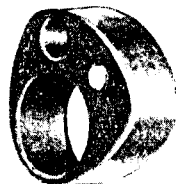
202737



204457



213007



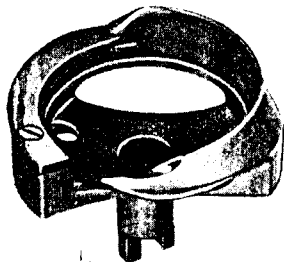
213112



223438



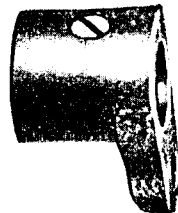
223435



204424



204308

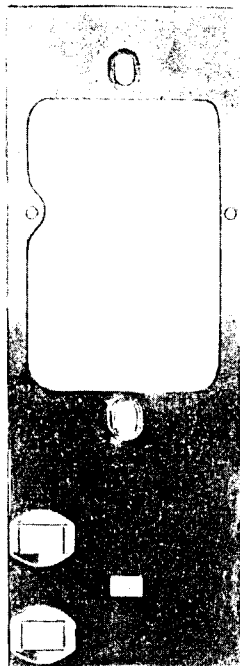


204387

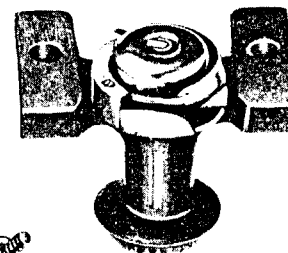


PLATE 14102—ONE-HALF SIZE

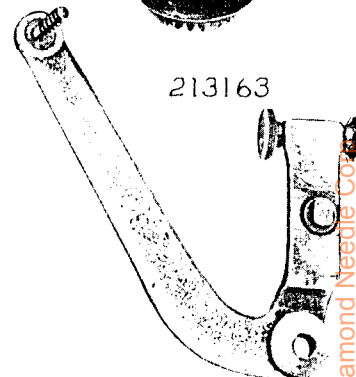
213162



223437



213163



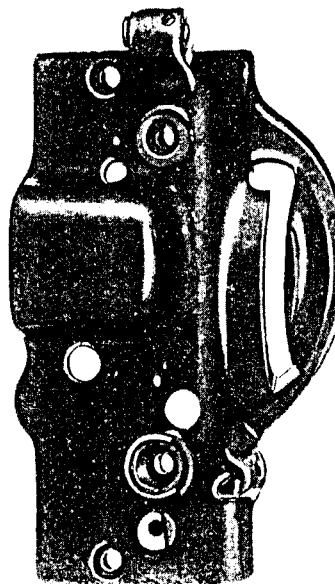
228182



228181



223421



From the library of Diamond Needle Co.

PLATE 14103—FULL SIZE

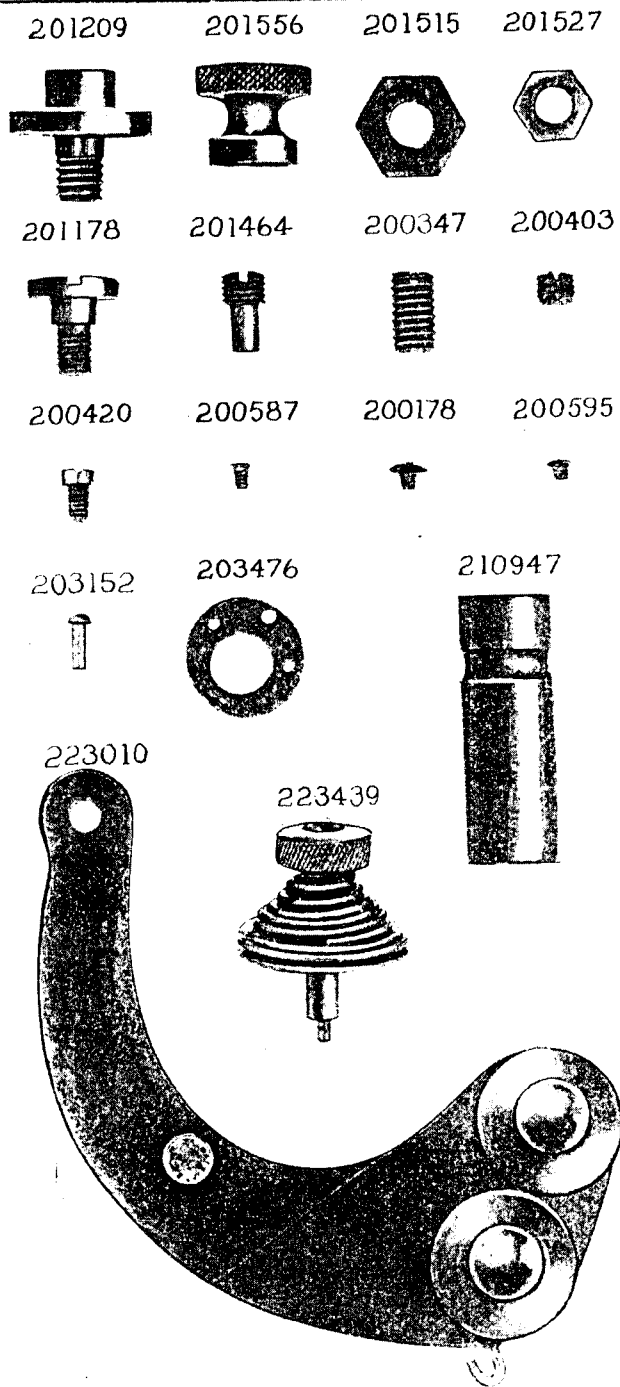
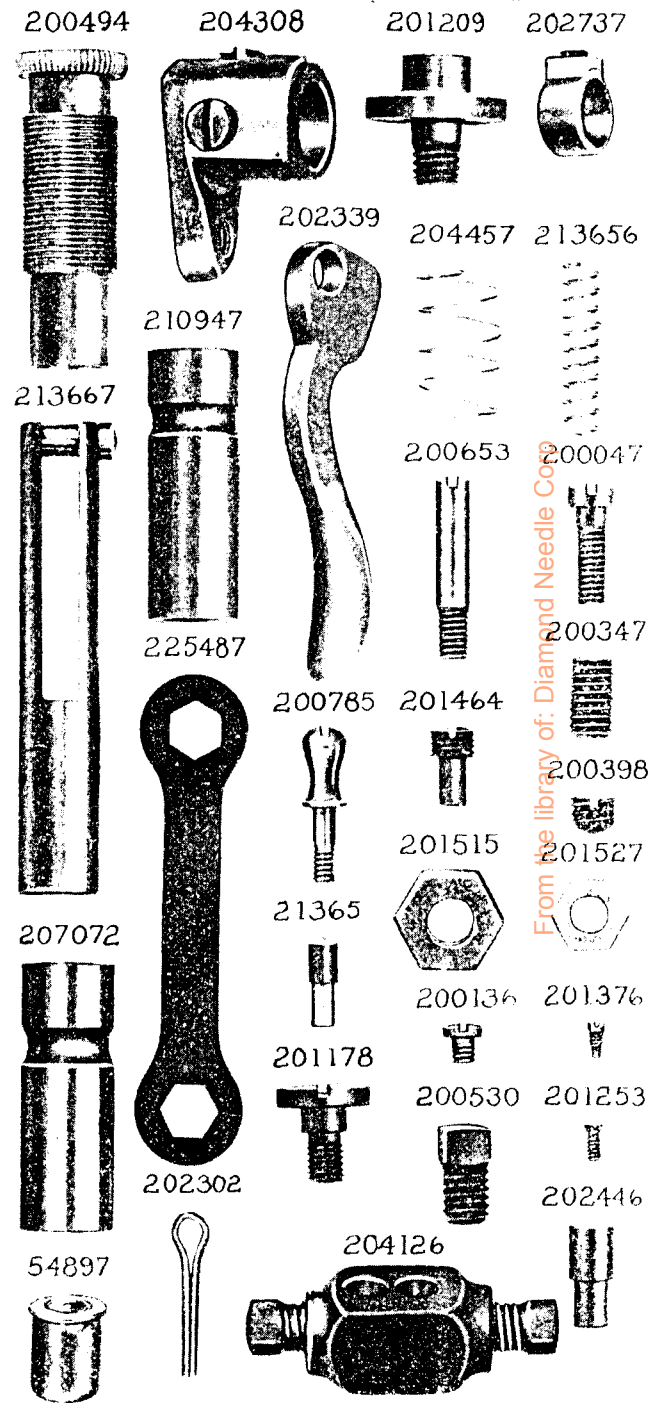


PLATE 14104—FULL SIZE



From the library of: Diamond Needle Co.

PLATE 14106—FULL SIZE

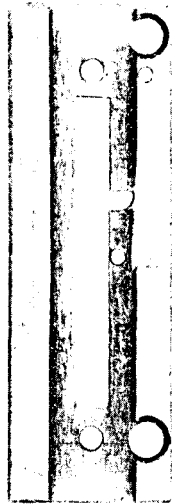
223443



223444



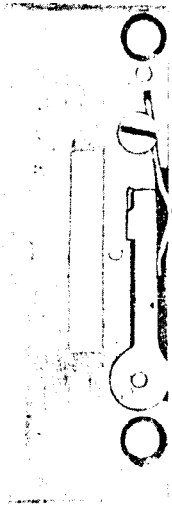
223445



223446



211463
211464



211540



211425



207651



211597



211416

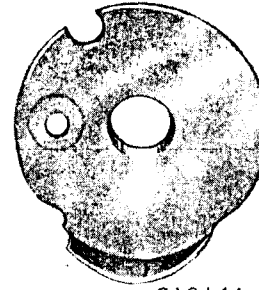


PLATE 14107—FULL SIZE

223439



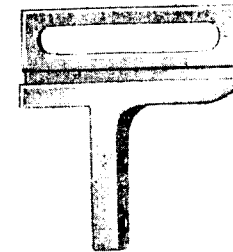
213018



202897



202895



208496



223423



213141



200898



201519



200378



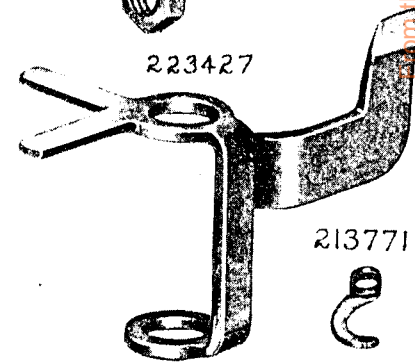
200583



200380



223427



213771



From the library of the University of Toronto

PLATE 14108—ONE-HALF SIZE

213879



228184

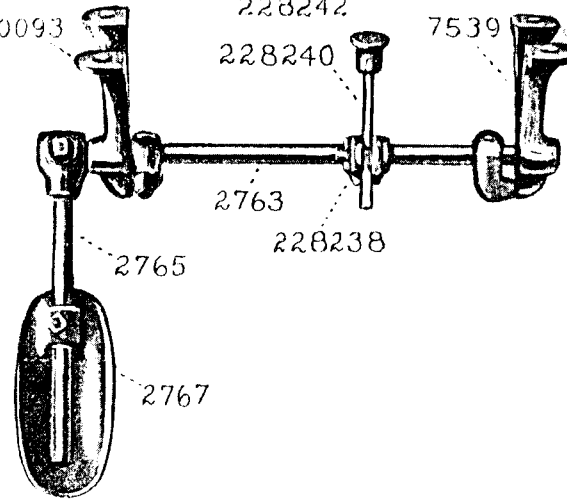


227449



PLATE 14171—ONE-FOURTH SIZE

20093



FULL SIZE

2766



2770



200529



228241



204225



8073



356



From the library of: Diamond Needle Corp

PLATE 14512—ONE-HALF SIZE

204306



204336

